



75W LED Driver with 3 Channel Constant Current Outputs PDA075W 0-10V Dimming LED Power Supply



Features

- Class 2 Output per UL1310
- OVP and Short-Circuit Protection
- 3 Channel Output
- IP66
- THD <20% & ≥ 0.9 Power Factor
- Brownout Protection

Applications

- Troffers

Safety Approvals

- cUL/UL8750
- Class 2 Output per UL1310

Mechanical Characteristics

- Length: 242mm (9.53in)
- Width: 43.5mm (1.71in)
- Height: 30.5mm (1.2in)
- Weight: 650g

Output Specifications

Channel 1~3

Model	DC Output Voltage			Output Current	Output Power
	Min.	Typ.	Max.		
PDA075W-T700G	28V	31V	33V	700mA	25W

Phihong is not responsible for any error, and reserves the right to make changes without notice. Please visit our website at www.phihong.com for the most up-to-date specifications and contact information.

INPUT:

AC Input Voltage
108~304VAC

Nominal AC Input Voltage
120~277VAC

Maximum Input Current
0.82A (RMS) at 108Vac, 60Hz

Leakage Current
0.75mA maximum at 277VAC

AC Inrush Current
<100A at 277VAC, 60 Hz

Power Factor
≥ 0.9

THD
< 20%

Ripple (Ch1~Ch3)
240mA p-p

Turn on/off Time
3 seconds maximum at nominal AC input
0.5 seconds maximum at nominal AC input

Efficiency
85% at 120VAC
85% at 277VAC
Typical Efficiency 87%

Standby Power
<1W maximum

**Environmental:
Temperature**

Operating 0 to Tc +70°C
Non-operation -40 to +85°C
Operating Humidity 10% to 95%

EMC

FCC 47 CFR Part 15, Class A

Immunity

IEC61000-4-2
IEC61000-4-5
IEC61000-4-11

Dielectric Withstand (Hi-pot) Test

Primary to secondary: 3000VAC for 1 minute, 10mA

Insulation Resistance

Primary to secondary: >5M Ohm 500VDC, 1 Minute

Short-Circuit Protection

Auto-Recovery

Open Circuit and Output Over-voltage Protection

Max Voltage Limit 42V

Input / Output Connections

Position	Terminal Color	Specification	Length
Input	Black	AWG16 Solid Wire	660mm
	White	AWG16 Solid Wire	660mm
Output	Red(+)	AWG18 Solid Wire	250mm
	Blue(-)	AWG18 Solid Wire	250mm
Dim+	Purple(+)	AWG18 Solid Wire	250mm
Dim-	Grey(-)	AWG18 Solid Wire	250mm
Auxiliary	Yellow	AWG18 Solid Wire	250mm

Warranty

5 Year

Dimming Curve

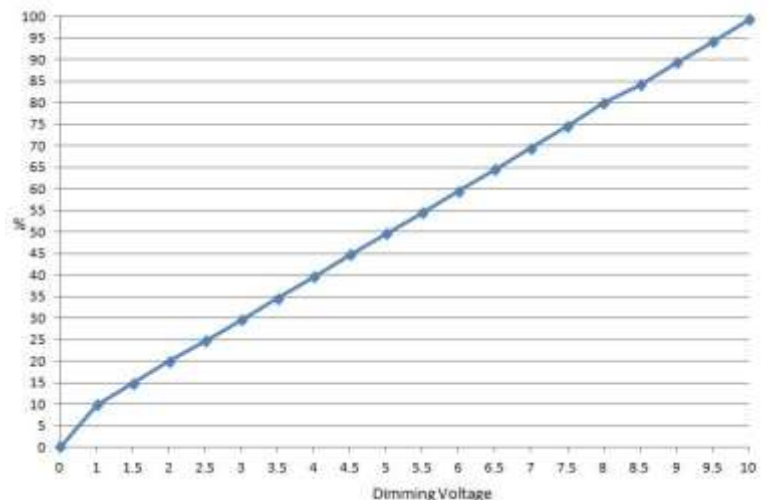

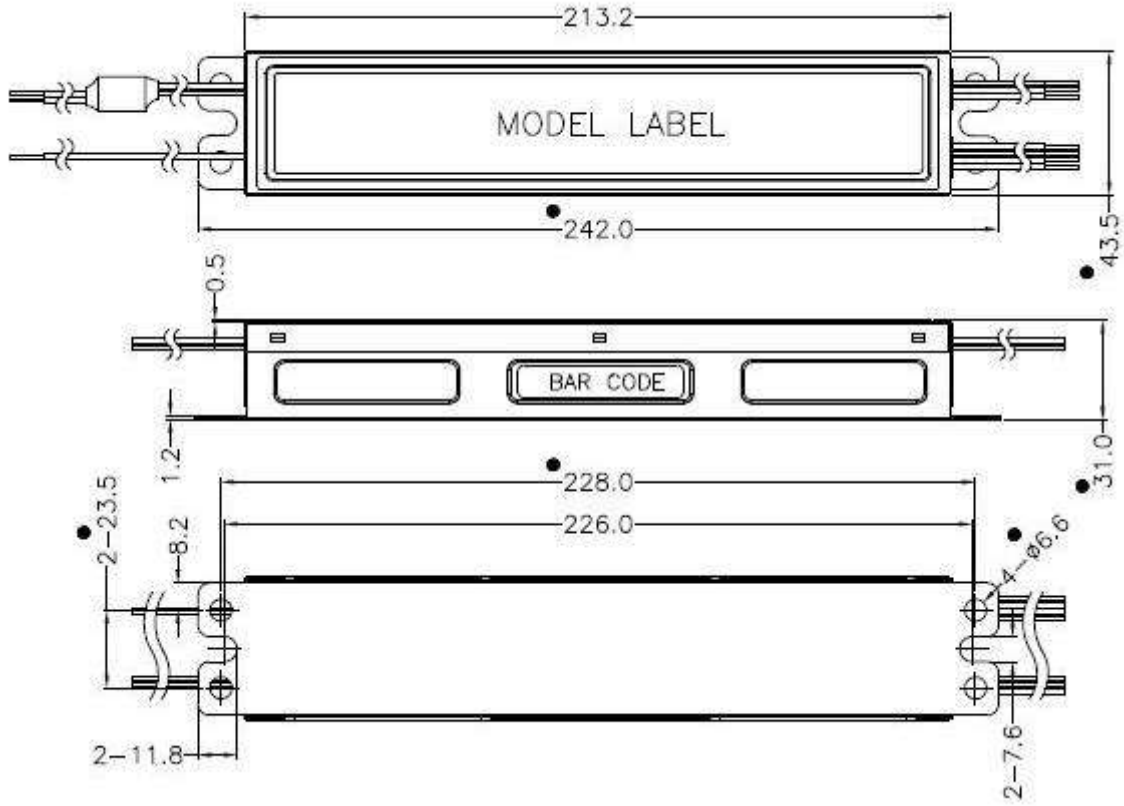

Power Factor vs. Load

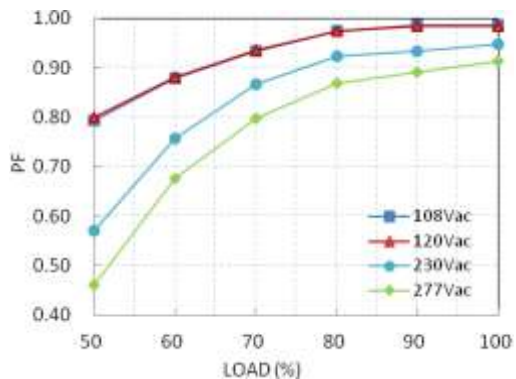

Total Harmonic Distortion vs. Load

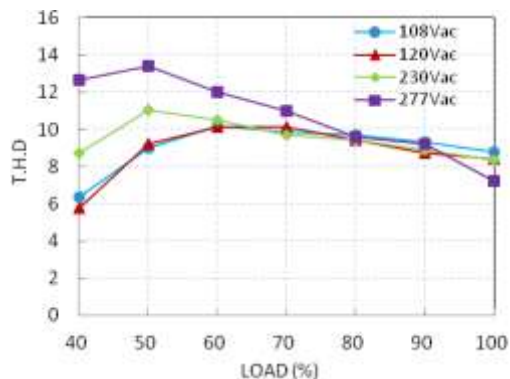

Lifetime vs. Tc

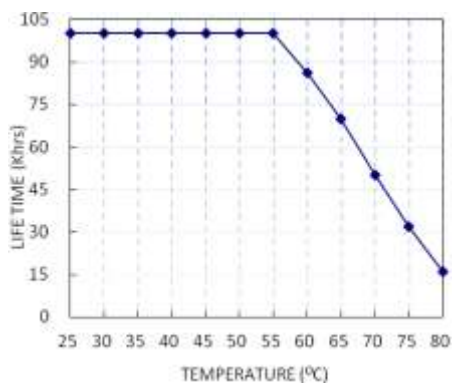

Efficiency vs. Load

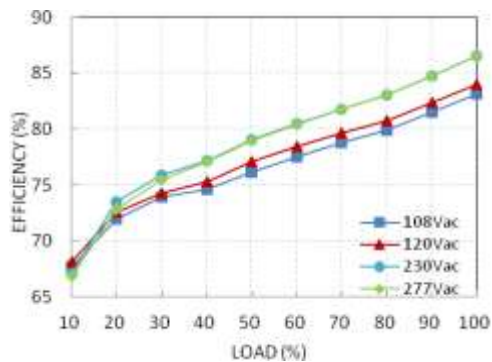

Temperature Rating

Static Characteristic: Load vs. Input Voltage

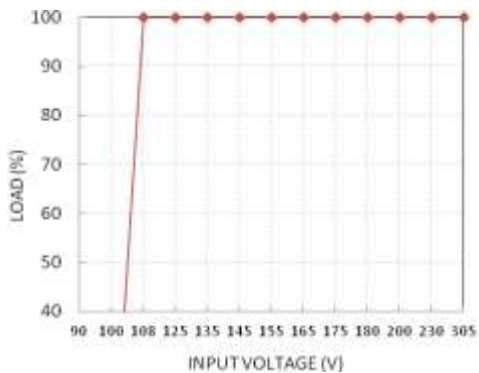

Derating Curve: Load vs. Ta

