

1.2MHz, 2A, High Efficiency PWM Step-Down DC/DC Converter

General Description

The RT8058A is a current mode PWM step-down converter. The chip is ideal for fixed frequency and low ripple applications over full range of load conditions. Its input voltage range is from 2.6V to 5.5V with a constant 1.2MHz switching frequency that allows it to adopt tiny, low cost capacitors and inductors with 2mm or less in height making it ideal for single-cell Li-Ion/polymer battery applications. The low on resistance internal MOSFET can achieve high efficiency without the need of external schottky diodes in wide operating ranges and the output voltage is adjustable from 0.6V to 5V that can provide up to 2A load current. The RT8058A operates at 100% duty cycle for low dropout operation that extends battery life in portable devices. The RT8058A is available in a WDFN-10L 3x3 package.

Ordering Information

RT8058A□□

- Package Type
QW : WDFN-10L 3x3 (W-Type)
- Lead Plating System
P : Pb Free
G : Green (Halogen Free and Pb Free)

Note :

Richtek products are :

- ▶ RoHS compliant and compatible with the current requirements of IPC/JEDEC J-STD-020.
- ▶ Suitable for use in SnPb or Pb-free soldering processes.

Marking Information

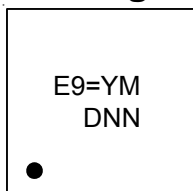

E9= : Product Code
YMDNN : Data Code

Features

- 0.6V Reference Allows Low Output Voltage
- Low Dropout Operation : 100% Duty Cycle
- 2A Load Current
- <2μA Shutdown Current
- Up to 95% Efficiency
- No Schottky Diode Required
- 1.2MHz Constant Switching Frequency
- Low R_{DS(ON)} Internal Switches
- Internally Compensated
- Internal Soft-Start
- Over temperature Protection
- Short Circuit Protection
- Small 10-Lead WDFN Package
- RoHS Compliant and Halogen Free

Applications

- Portable Instruments
- Microprocessors and DSP Core supplies
- Cellular Telephones
- Wireless and DSL Modems
- Digital Cameras
- PC Cards

Pin Configurations

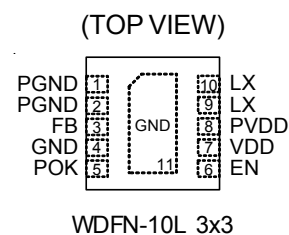

Typical Application Circuit

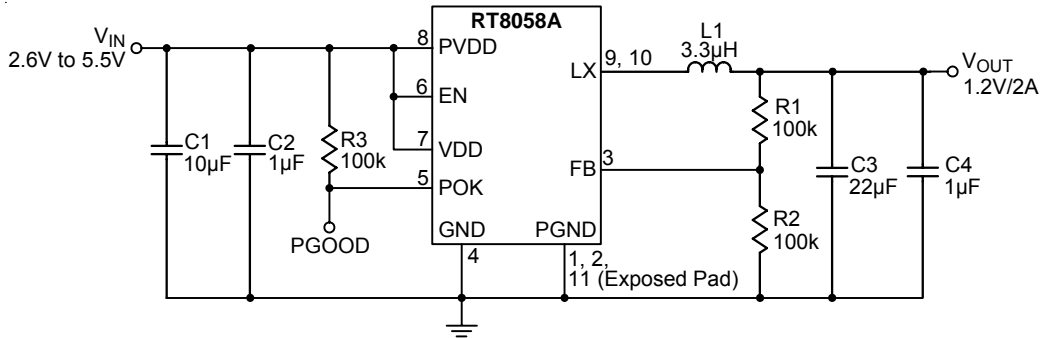

Functional Pin Description

Pin No.	Pin Name	Pin Function
1, 2, 11 (Exposed Pad)	PGND	Power Ground. Connect this pin close to the (-) terminal of C _{IN} and C _{OUT} . Exposed pad should be soldered to PCB board and connected to GND.
3	FB	Feedback Input Pin. Receives the feedback voltage from a resistive divider connected across the output.
4	GND	Signal Ground. Return the feedback resistive dividers to this ground, which in turn connects to PGND at one point.
5	POK	Power Good Indicator. Open-drain logic output that is opened when the output voltage exceeds 90% of the regulation point.
6	EN	Enable pin. A logical high level at this pin enables the converter, while a logical low level causes the converter to shut down.
7	VDD	Signal Input Supply. Decouple this pin to GND with a capacitor. Normally VDD is equal to PVDD.
8	PVDD	Power Input Supply of converter power stage. Decouple this pin to PGND with a capacitor.
9, 10	LX	Internal Power MOSFET Switches Output of converter. Connect this pin to the inductor.

Function Block Diagram

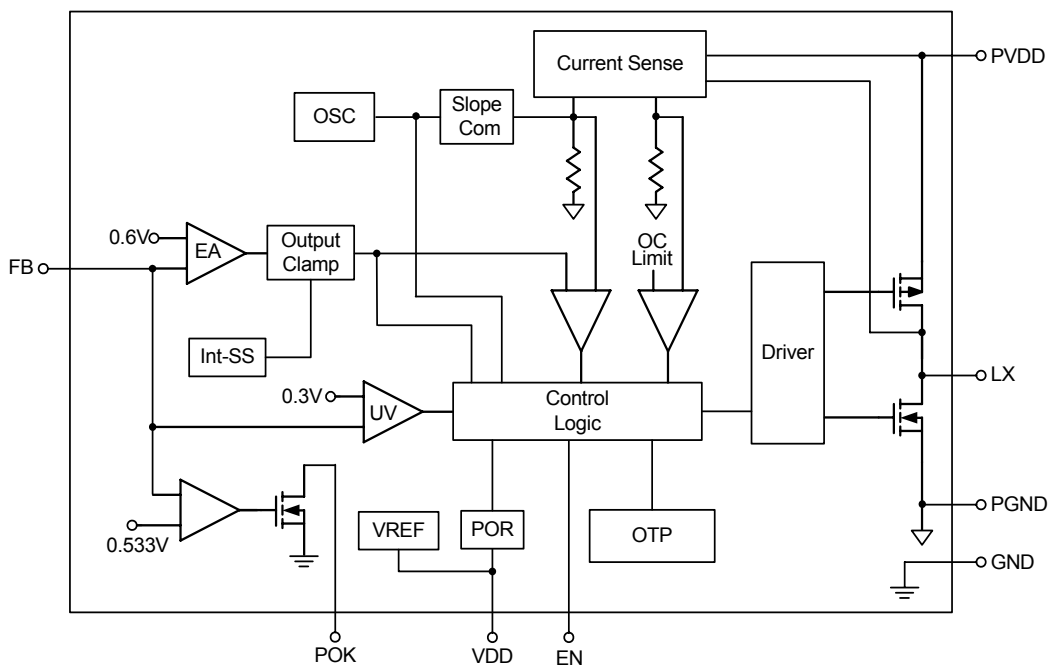

Absolute Maximum Ratings (Note 1)

- Supply Input Voltage VDD, PVDD ----- -0.3V to 6V
- LX Pin Switch Voltage ----- -0.3V to 6V
- Other I/O Pin Voltage ----- -0.3V to 6V
- Power Dissipation, P_D @ T_A = 25°C
 - WDFN-10L 3x3 ----- 1.429W
- Package Thermal Resistance (Note 2)
 - WDFN-10L 3x3, θ_{JA} ----- 70°C/W
 - WDFN-10L 3x3, θ_{JC} ----- 7.8°C/W
- Lead Temperature (Soldering, 10 sec.) ----- 260°C
- Storage Temperature Range ----- -65°C to 150°C
- Junction Temperature ----- 150°C
- ESD Susceptibility (Note 3)
 - HBM (Human Body Mode) ----- 2kV
 - MM (Machine Mode) ----- 200V

Recommended Operating Conditions (Note 4)

- Supply Input Voltage ----- 2.6V to 5.5V
- Junction Temperature Range ----- -40°C to 125°C
- Ambient Temperature Range ----- -40°C to 85°C

Electrical Characteristics

(V_{DD} = V_{PVDD} = 3.6V, T_A = 25°C, unless otherwise specified)

Parameter	Symbol	Test Conditions	Min	Typ	Max	Unit
Input Voltage Range	V _{IN}		2.6	--	5.5	V
Feedback Reference Voltage	V _{REF}		0.582	0.6	0.618	V
DC Bias Current (PVDD, VDD total)		Active, No Load	--	3.4	--	mA
		Active, Not Switching, V _{FB} = 0.5V	--	340	--	μA
		Shutdown, EN = 0	--	--	2	μA
Under voltage Lockout Threshold	UVLO	V _{DD} Rising	2.3	2.43	2.55	V
		V _{DD} Hysteresis	--	150	--	mV
Oscillator Frequency	f _{OSC}	Switching Frequency	1	1.2	1.4	MHz
EN High-Level Input Voltage	V _{EN_H}		1.4	--	--	V
EN Low-Level Input Voltage	V _{EN_L}		--	--	0.4	V
Switch On Resistance, High	R _{DS(ON)_P}	I _{OUT} = 200mA	--	142	210	mΩ
Switch On Resistance, Low	R _{DS(ON)_N}	I _{OUT} = 200mA	--	96	160	mΩ
Peak Current Limit	I _{LIM}		2.2	3	--	A
Output Voltage Line Regulation		V _{IN} = 2.6V to 5.5V, I _{OUT} = 0	--	0.05	--	%/V
Output Voltage Load		I _{OUT} = 0A → 2A	--	1	--	%/A

Note 1. Stresses listed as the above “Absolute Maximum Ratings” may cause permanent damage to the device. These are for stress ratings. Functional operation of the device at these or any other conditions beyond those indicated in the operational sections of the specifications is not implied. Exposure to absolute maximum rating conditions for extended periods may remain possibility to affect device reliability.

Note 2. θ_{JA} is measured in the natural convection at $T_A = 25^\circ\text{C}$ on a high effective four layers thermal conductivity test board of JEDEC 51-7 thermal measurement standard. The case point of θ_{JC} is on the exposed pad of the package.

Note 3. Devices are ESD sensitive. Handling precaution is recommended.

Note 4. The device is not guaranteed to function outside its operating conditions.

Typical Operating Characteristics

Efficiency vs. Output Current

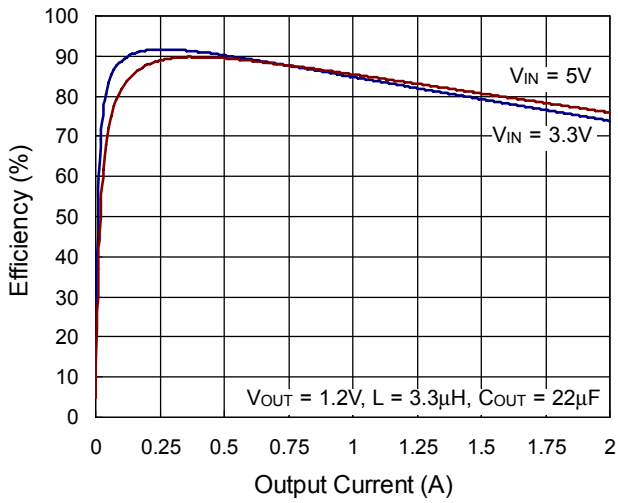

Output Voltage vs. Output Current

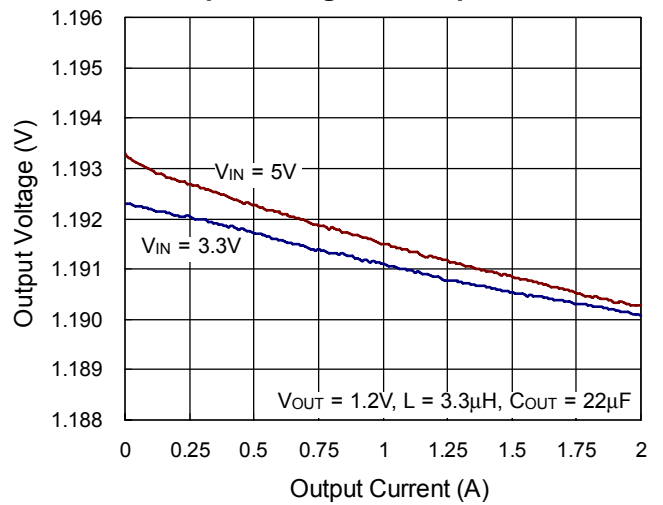

Output Voltage vs. Input Voltage

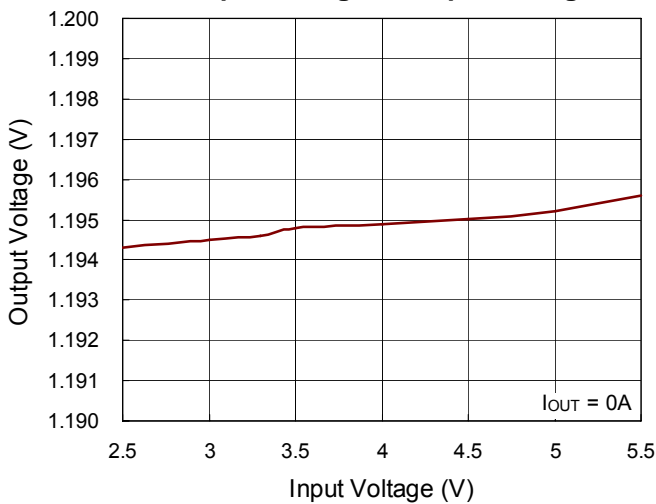

FB Voltage vs. Temperature

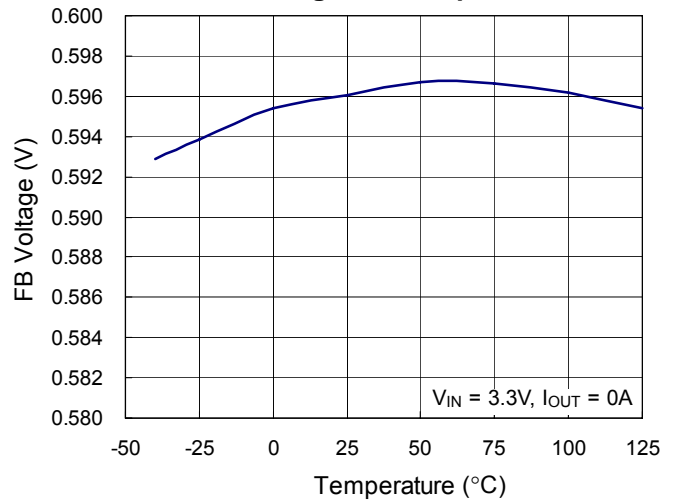

Switching Frequency vs. Input Voltage

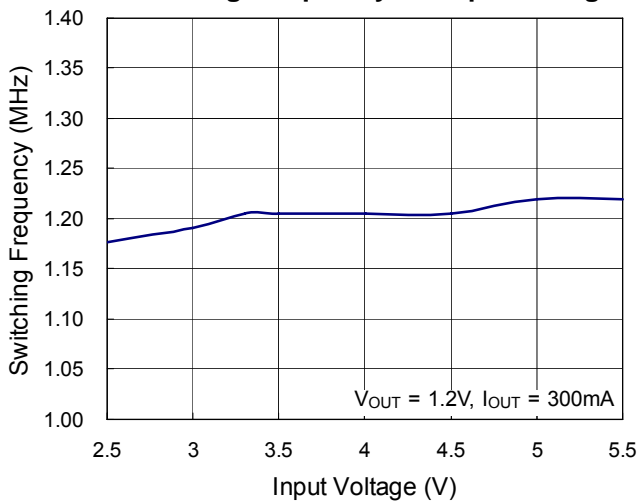

Switching Frequency vs. Temperature

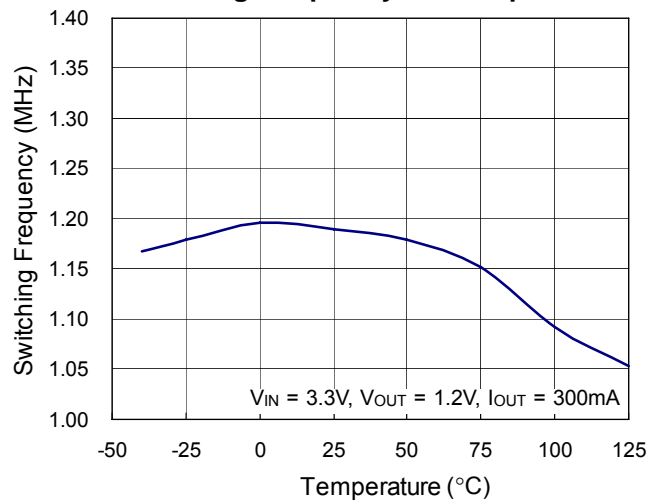

EN Voltage vs. Input Voltage

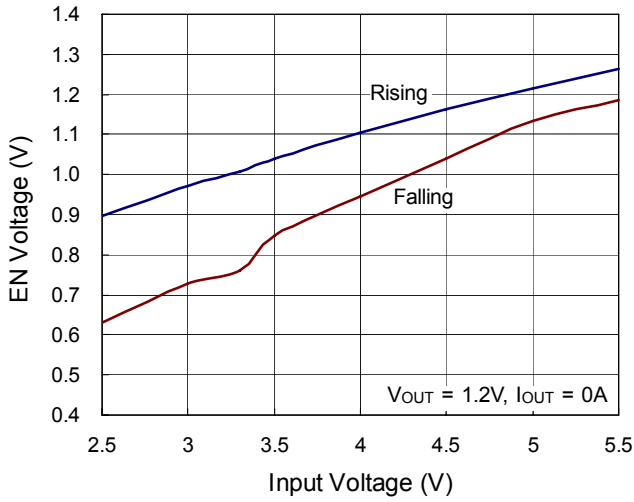

EN Voltage vs. Temperature

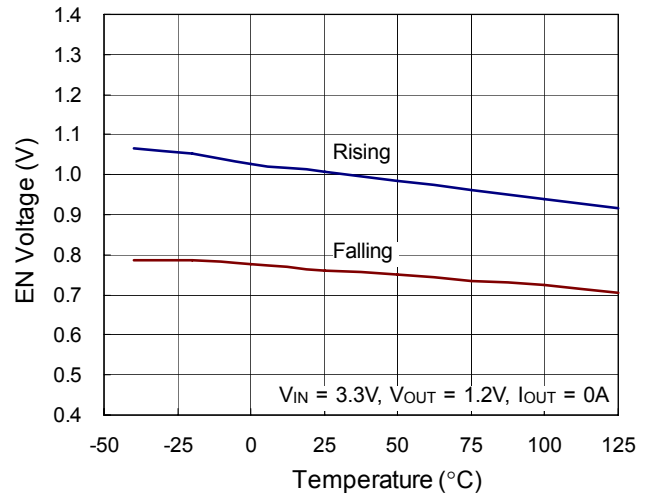

Output Current vs. Input Voltage

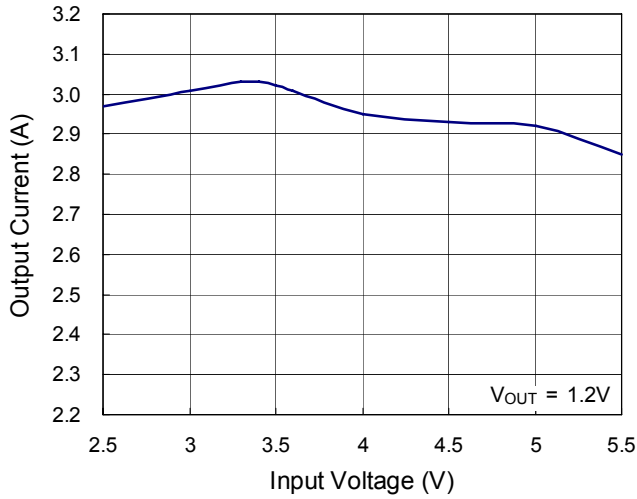

Output Current vs. Temperature

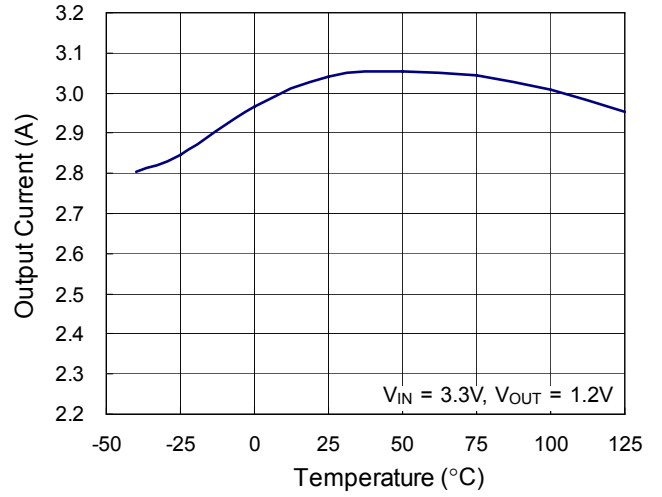

Load Transient Response

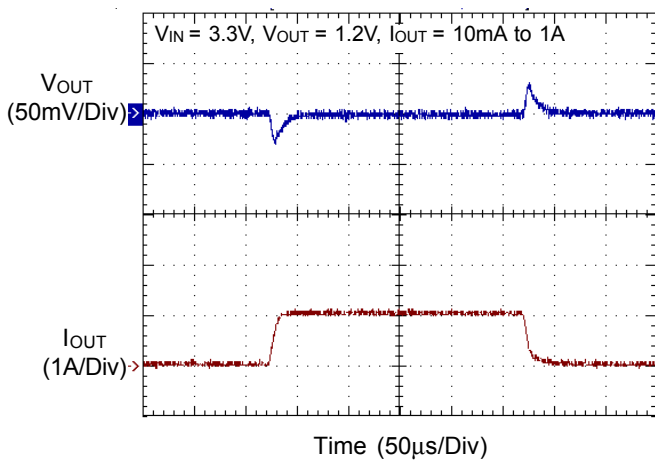

Load Transient Response

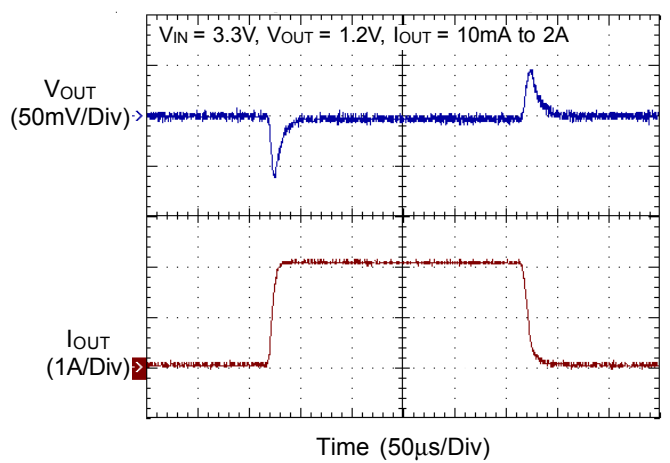

Load Transient Response

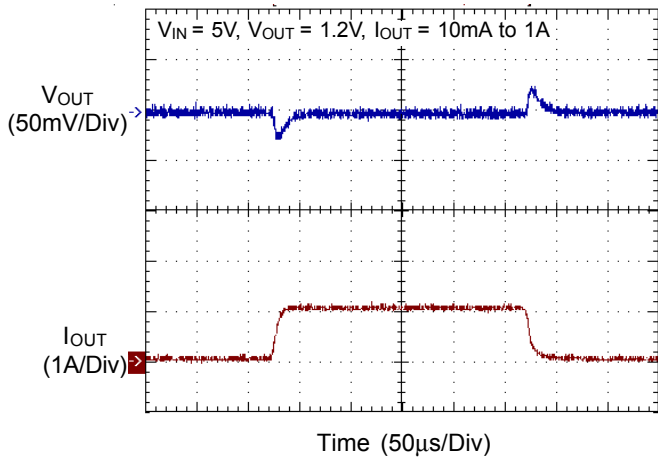

Load Transient Response

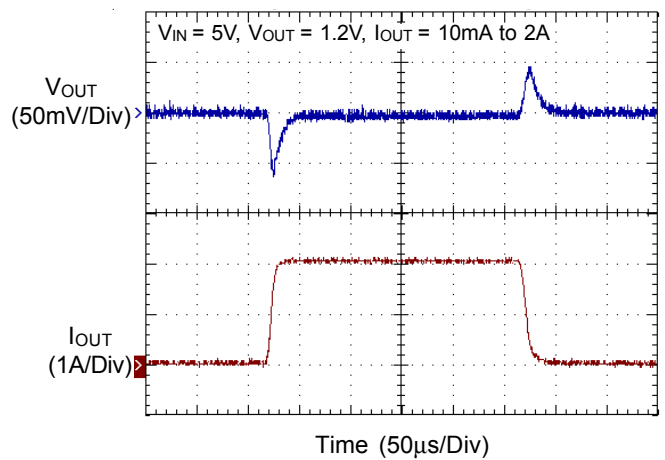

Output Ripple Voltage

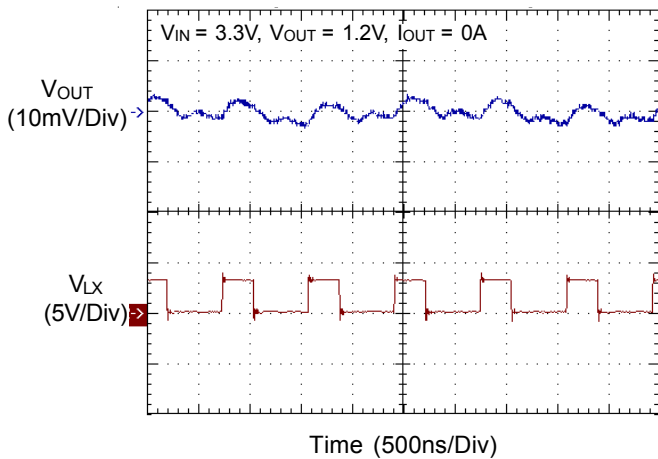

Output Ripple Voltage

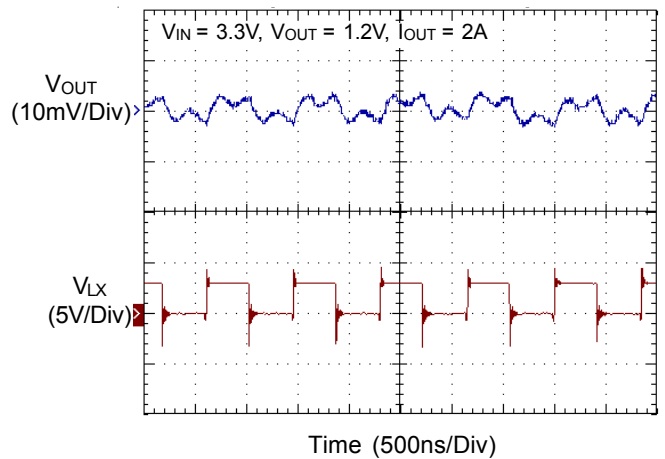

Output Ripple Voltage

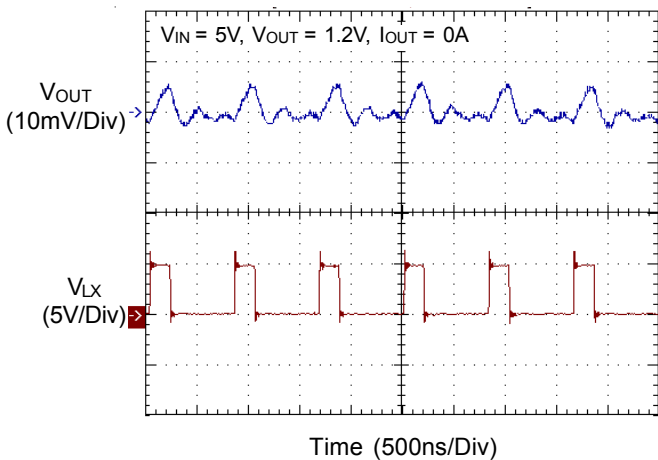

Output Ripple Voltage

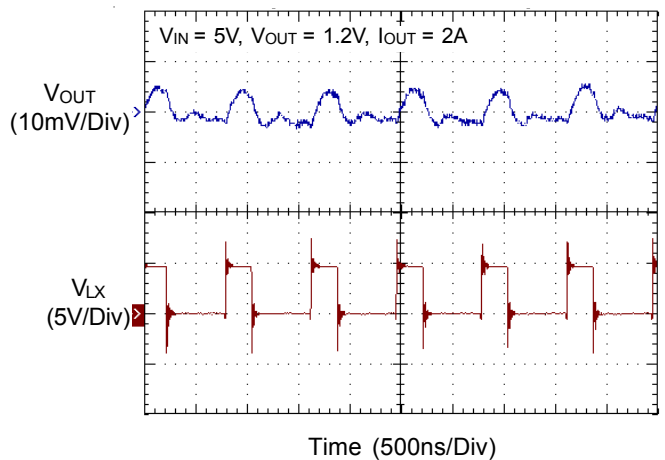

Power On from EN

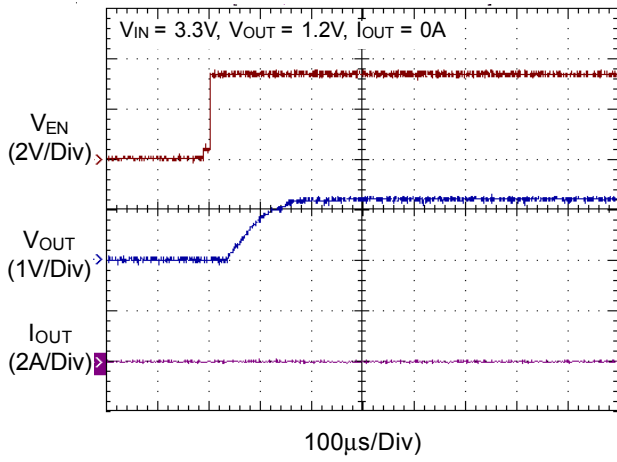

Power On from EN

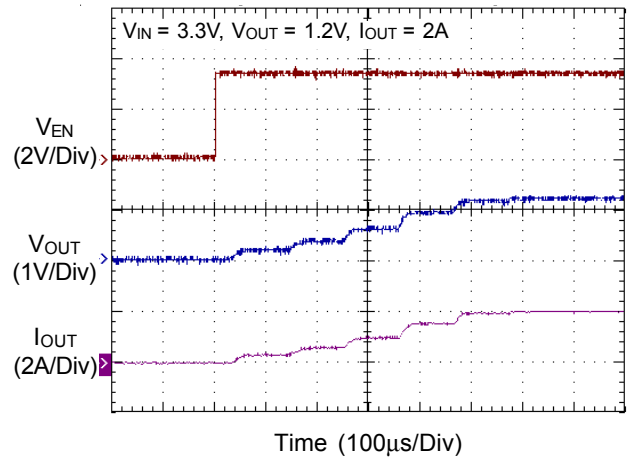

Power On from VIN

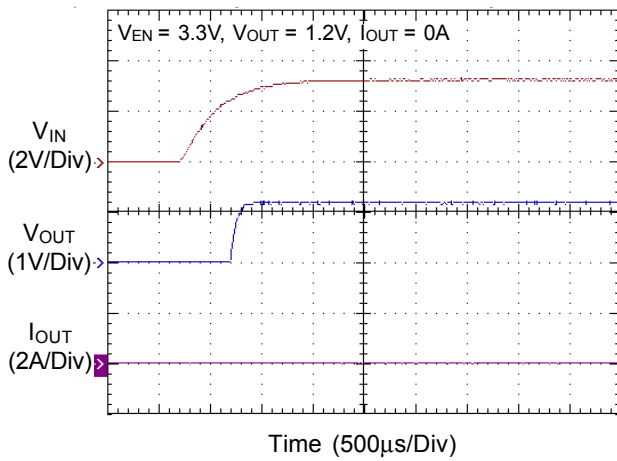

Power On from VIN

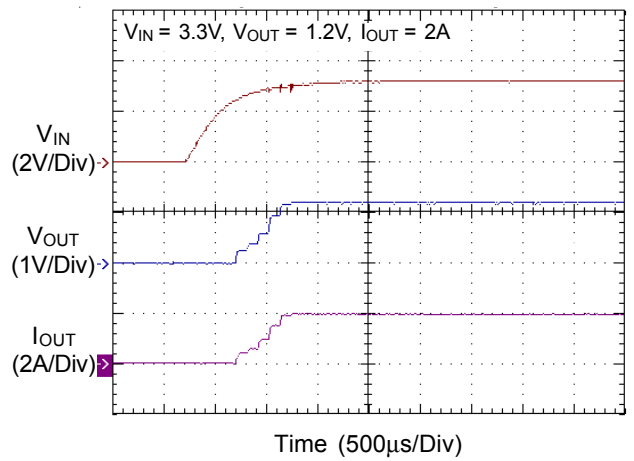

Power Off from EN

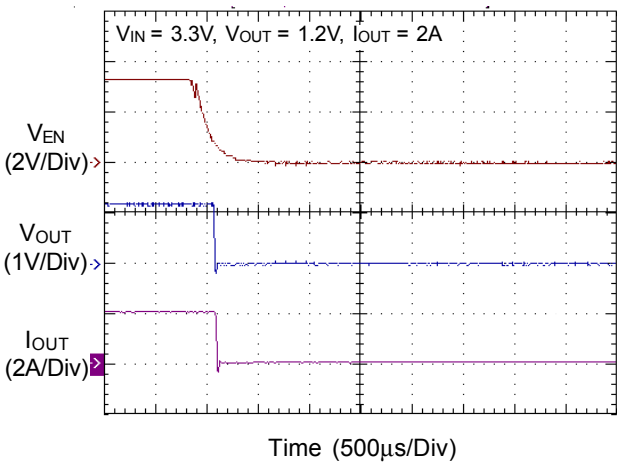

Power Off from EN

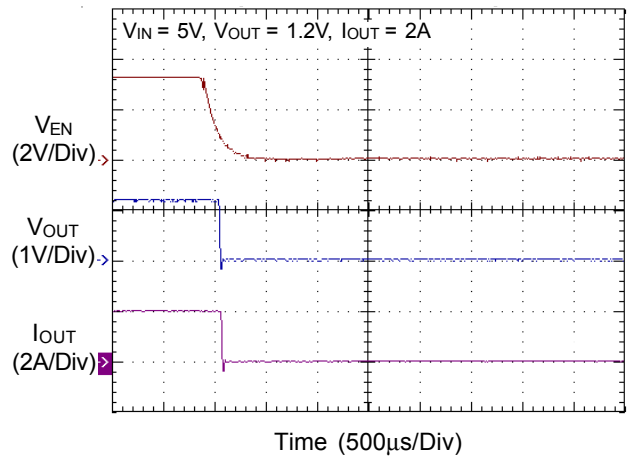

Application Information

Function Description

The RT8058A is a 1.2MHz constant frequency, current mode PWM step-down converter. High switching frequency and high efficiency make it suitable for applications where high efficiency and small size are critical.

The output voltages are set by external dividers returned to the FB pin. The output voltage can be set from 0.6V to 5V.

Main Control Loop

During normal operation, the internal top power switch (P-MOSFET) is turned on at the beginning of each clock cycle. Current in the inductor increases until the peak inductor current reach the value defined by the output voltage of the error amplifier. The error amplifier adjusts its output voltage by comparing the feedback signal from a resistor divider on the FB pin with an internal 0.6V reference. When the load current increases, it causes a reduction in the feedback voltage relative to the reference. The error amplifier raises its output voltage until the average inductor current matches the new load current. When the top power MOSFET shuts off, the synchronous power switch (N-MOSFET) turns on until the beginning of the next clock cycle.

Soft-Start / Enable

For convenience of power up sequence control, the RT8058A has an enable pin. Logic high at EN pin will enable the converter. When the converter is enabled, the clamped error amplifier output ramps up during 1024-clock period to increase the current provided by converter until the output voltage reach the target voltage. If EN is kept at high during V_{IN} applying, the RT8058A will be enabled when VDD surpass Under Voltage Lockout threshold.

Output Voltage Programming

The output voltage is set by an external resistive divider according to the following equation :

$$V_{OUT} = V_{REF} \times (1 + R1/R2)$$

where V_{REF} equals to 0.6V typical.

The resistive divider allows the FB pin to sense a fraction of the output voltage as shown in Figure 1.

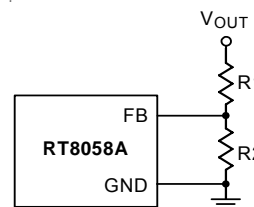

Figure 1. Setting the Output Voltage

Slope Compensation and Inductor Peak Current

Slope compensation provides stability in constant frequency architectures by preventing sub harmonic oscillations at duty cycles greater than 50%. It is accomplished internally by adding a compensating ramp to the inductor current signal. Normally, the maximum inductor peak current is reduced when slope compensation is added. In RT8058A, however, separated inductor current signal is used to monitor over current condition and this keeps the maximum output current relatively constant regardless of duty cycle.

Dropout Operation

When input supply voltage decreases toward the output voltage, the duty cycle increases toward the maximum on time. Further reduction of the supply voltage forces the main switch to remain on for more than one cycle eventually reaching 100% duty cycle. The output voltage will then be determined by the input voltage minus the voltage drop across the internal P-MOSFET and the inductor.

Low Supply Operation

The RT8058A is designed to operate down to an input supply voltage of 2.6V. One important consideration at low input supply voltages is that the $R_{DS(ON)}$ of the P-Channel and N-Channel power switches increases. The user should calculate the power dissipation when the RT8058A is used at 100% duty cycle with low input voltages to ensure that thermal limits are not exceeded.

Short Circuit Protection

At overload condition, current mode operation provides cycle-by-cycle current limit to protect the internal power switches. When the output is shorted to ground, the inductor current will decay very slowly during a single switching cycle. A current runaway detector is used to monitor inductor current. As current increasing beyond the control of current loop, switching cycles will be skipped to prevent current runaway from occurring. If the FB voltage is smaller than 0.3V after the completion of soft-start period, Under Voltage Protection (UVP) will lock the output to high-z to protect the converter. UVP lock can only be cleared by recycling the input power.

Thermal Protection

If the junction temperature of the RT8058A reaches certain temperature (150°C), both converters will be disabled. The RT8058 will be re-enabled and automatically initializes internal soft start when the junction temperature drops below 110°C.

Inductor Selection

For a given input and output voltage, the inductor value and operating frequency determine the ripple current. The ripple current ΔI_L increases with higher V_{IN} and decreases with higher inductance.

$$\Delta I_L = \left[\frac{V_{OUT}}{f \times L} \right] \times \left[1 - \frac{V_{OUT}}{V_{IN}} \right]$$

Having a lower ripple current reduces the ESR losses in the output capacitors and the output voltage ripple. Highest efficiency operation is achieved at low frequency with small ripple current. This, however, requires a large inductor. A reasonable starting point for selecting the ripple current is $\Delta I_L = 0.4(I_{MAX})$. The largest ripple current occurs at the highest V_{IN} . To guarantee that the ripple current stays below a specified maximum, the inductor value should be chosen according to the following equation :

$$L = \left[\frac{V_{OUT}}{f \times \Delta I_L(MAX)} \right] \times \left[1 - \frac{V_{OUT}}{V_{IN(MAX)}} \right]$$

Inductor Core Selection

Once the value for L is known, the type of inductor must be selected. High efficiency converters generally cannot afford the core loss found in low cost powdered iron cores,

forcing the use of more expensive ferrite or mollypermalloy cores. Actual core loss is independent of core size for a fixed inductor value but it is very dependent on the inductance selected. As the inductance increases, core losses decrease. Unfortunately, increased inductance requires more turns of wire and therefore copper losses will increase.

Ferrite designs have very low core losses and are preferred at high switching frequencies, so design goals can concentrate on copper loss and preventing saturation. Ferrite core material saturates "hard", which means that inductance collapses abruptly when the peak design current is exceeded. This result in an abrupt increase in inductor ripple current and consequent output voltage ripple.

Do not allow the core to saturate!

Different core materials and shapes will change the size/current and price/current relationship of an inductor. Toroid or shielded pot cores in ferrite or permalloy materials are small and don't radiate energy but generally cost more than powdered iron core inductors with similar characteristics. The choice of which style inductor to use mainly depends on the price vs. size requirements and any radiated field/EMI requirements.

C_{IN} and C_{OUT} Selection

The input capacitance, C_{IN} , is needed to filter the trapezoidal current at the source of the top MOSFET. To prevent large ripple voltage, a low ESR input capacitor sized for the maximum RMS current should be used. RMS current is given by :

$$I_{RMS} = I_{OUT(MAX)} \frac{V_{OUT}}{V_{IN}} \sqrt{\frac{V_{IN}}{V_{OUT}} - 1}$$

This formula has a maximum at $V_{IN} = 2V_{OUT}$, where $I_{RMS} = I_{OUT}/2$. This simple worst-case condition is commonly used for design because even significant deviations do not offer much relief. Note that ripple current ratings from capacitor manufacturers are often based on only 2000 hours of life which makes it advisable to further derate the capacitor, or choose a capacitor rated at a higher temperature than required. Several capacitors may also be paralleled to meet size or height requirements in the design.

The selection of C_{OUT} is determined by the Effective Series Resistance (ESR) that is required to minimize voltage ripple and load step transients, as well as the amount of bulk capacitance that is necessary to ensure that the control loop is stable. Loop stability can be checked by viewing the load transient response as described in a later section. The output ripple, ΔV_{OUT} , is determined by :

$$\Delta V_{OUT} \leq \Delta I_L \left[ESR + \frac{1}{8fC_{OUT}} \right]$$

The output ripple is highest at maximum input voltage since ΔI_L increases with input voltage. Multiple capacitors placed in parallel may be needed to meet the ESR and RMS current handling requirements. Dry tantalum, special polymer, aluminum electrolytic and ceramic capacitors are all available in surface mount packages. Special polymer capacitors offer very low ESR but have lower capacitance density than other types. Tantalum capacitors have the highest capacitance density but it is important to only use types that have been surge tested for use in switching power supplies. Aluminum electrolytic capacitors have significantly higher ESR but can be used in cost-sensitive applications provided that consideration is given to ripple current ratings and long term reliability. Ceramic capacitors have excellent low ESR characteristics but can have a high voltage coefficient and audible piezoelectric effects. The high Q of ceramic capacitors with trace inductance can also lead to significant ringing.

Using Ceramic Input and Output Capacitors

Higher values, lower cost ceramic capacitors are now becoming available in smaller case sizes. Their high ripple current, high voltage rating and low ESR make them ideal for switching regulator applications. However, care must be taken when these capacitors are used at the input and output. When a ceramic capacitor is used at the input and the power is supplied by a wall adapter through long wires, a load step at the output can induce ringing at the input, V_{IN} . At best, this ringing can couple to the output and be mistaken as loop instability. At worst, a sudden inrush of current through the long wires can potentially cause a voltage spike at V_{IN} large enough to damage the part.

Checking Transient Response

The regulator loop response can be checked by looking at the load transient response. Switching regulators take several cycles to respond to a step in load current. When a load step occurs, V_{OUT} immediately shifts by an amount equal to $\Delta I_{LOAD(ESR)}$, where ESR is the effective series resistance of C_{OUT} . ΔI_{LOAD} also begins to charge or discharge C_{OUT} generating a feedback error signal used by the regulator to return V_{OUT} to its steady-state value. During this recovery time, V_{OUT} can be monitored for overshoot or ringing that would indicate a stability problem.

Thermal Considerations

For continuous operation, do not exceed absolute maximum operation junction temperature. The maximum power dissipation depends on the thermal resistance of IC package, PCB layout, the rate of surroundings airflow and temperature difference between junction to ambient. The maximum power dissipation can be calculated by following formula :

$$P_{D(MAX)} = (T_{J(MAX)} - T_A) / \theta_{JA}$$

Where $T_{J(MAX)}$ is the maximum operation junction temperature, T_A is the ambient temperature and the θ_{JA} is the junction to ambient thermal resistance.

For recommended operating conditions specification of RT8058A, The maximum junction temperature is 125°C. The junction to ambient thermal resistance θ_{JA} is layout dependent. For WDFN-10L 3x3 packages, the thermal resistance θ_{JA} is 70°C/W on the standard JEDEC 51-7 four layers thermal test board. The maximum power dissipation at $T_A = 25^\circ\text{C}$ can be calculated by following formula :

$$P_{D(MAX)} = (125^\circ\text{C} - 25^\circ\text{C}) / (70^\circ\text{C/W}) = 1.429\text{W for WDFN-10L 3x3 packages}$$

The maximum power dissipation depends on operating ambient temperature for fixed $T_{J(MAX)}$ and thermal resistance θ_{JA} . For RT8058A packages, the Figure 2 of derating curves allows the designer to see the effect of rising ambient temperature on the maximum power allowed.

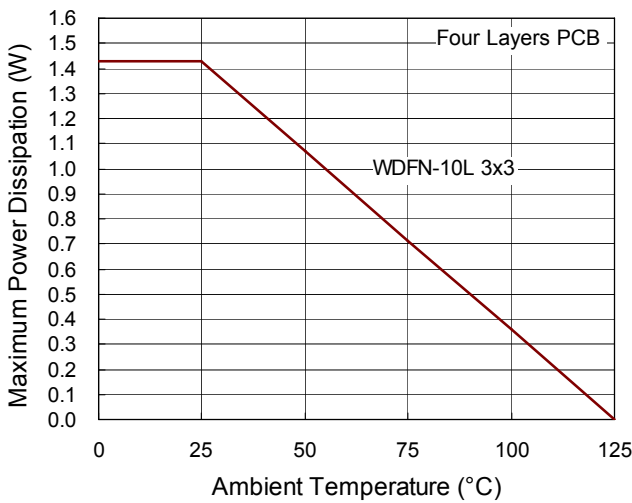

Figure 2. Derating Curves for RT8058A Package

Layout Considerations

Follow the PCB layout guidelines for optimal performance of RT8058A.

- ▶ A ground plane is recommended. If a ground plane layer

is not used, the signal and power grounds should be segregated with all small-signal components returning to the GND pin at one point that is then connected to the PGND pin close to the IC. The exposed pad should be connected to GND.

- ▶ Connect the terminal of the input capacitor(s), as close as possible to the PVDD pin. This capacitor provides the AC current into the internal power MOSFETs.
- ▶ LX node is with high frequency voltage swing and should be kept small area. Keep all sensitive small-signal nodes away from LX node to prevent stray capacitive noise pick-up.
- ▶ Flood all unused areas on all layers with copper. Flooding with copper will reduce the temperature rise of power components. The copper areas can be connectde to any DC net (PVDD, VDD, VOUT, PGND, GND, or any other DC rail in your system).
- ▶ Connect the FB pin directly to the feedback resistors. The resistor divider must be connected between VOUT and GND.

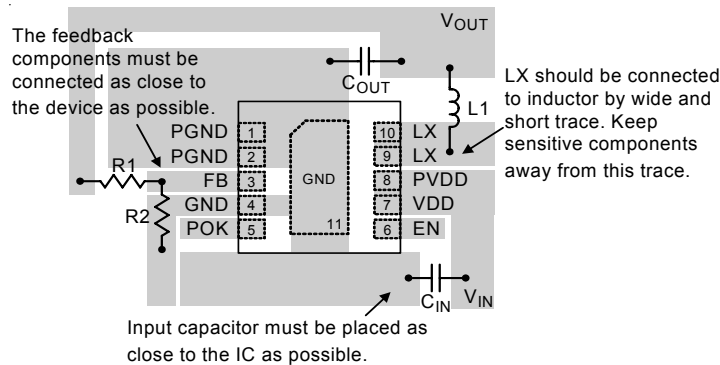

Figure 3. PCB Layout Guide

Table 1. Recommended Inductors

Component Supplier	Series	Inductance (mH)	DCR (mW)	Current Rating (mA)	Dimensions (mm)
TAIYO YUDEN	NR 4018	3.3	70	2000	4 x 4 x 1.8
Murata	LQH66S	3.3	22	2600	6.3 x 6.3 x 4.7
TDK	SLF7045T	3.3	20	2500	7 x 7 x 4.5
Sumida	CDRH5D16	3.3	36	2600	5.8 x 5.8 x 1.8
GOTREND	GTSD53	3.3	34	2360	5 x 5 x 2.8

Table 2. Recommended Capacitors for C_{IN} and C_{OUT}

Component Supplier	Part No.	Capacitance (mF)	Case Size
TDK	C3225X5R0J226M	22	1210
TDK	C2012X5R0J106M	10	0805
Panasonic	ECJ4YB1A226M	22	1210
Panasonic	ECJ4YB1A106M	10	1210
TAIYO YUDEN	LMK325BJ226ML	22	1210
TAIYO YUDEN	JMK316BJ226ML	22	1206
TAIYO YUDEN	JMK212BJ106ML	10	0805

Outline Dimension

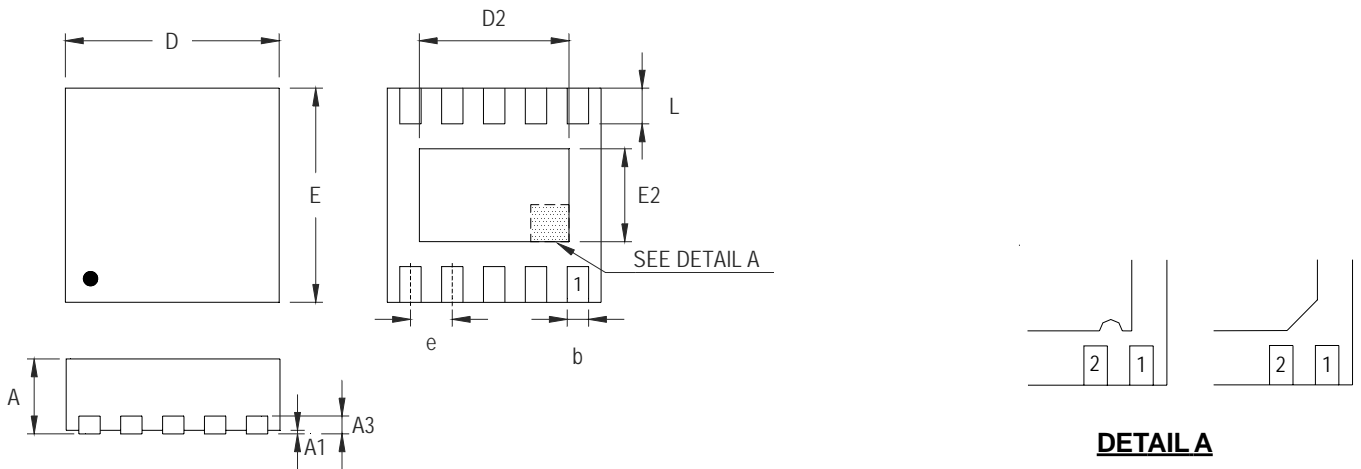

DETAIL A
Pin #1 ID and Tie Bar Mark Options

Note : The configuration of the Pin #1 identifier is optional, but must be located within the zone indicated.

Symbol	Dimensions In Millimeters		Dimensions In Inches	
	Min	Max	Min	Max
A	0.700	0.800	0.028	0.031
A1	0.000	0.050	0.000	0.002
A3	0.175	0.250	0.007	0.010
b	0.180	0.300	0.007	0.012
D	2.950	3.050	0.116	0.120
D2	2.300	2.650	0.091	0.104
E	2.950	3.050	0.116	0.120
E2	1.500	1.750	0.059	0.069
e	0.500		0.020	
L	0.350	0.450	0.014	0.018

W-Type 10L DFN 3x3 Package

Richtek Technology Corporation

Headquarter
5F, No. 20, Taiyuen Street, Chupei City
Hsinchu, Taiwan, R.O.C.
Tel: (8863)5526789 Fax: (8863)5526611

Richtek Technology Corporation

Taipei Office (Marketing)
5F, No. 95, Minchiuan Road, Hsintien City
Taipei County, Taiwan, R.O.C.
Tel: (8862)86672399 Fax: (8862)86672377
Email: marketing@richtek.com

Information that is provided by Richtek Technology Corporation is believed to be accurate and reliable. Richtek reserves the right to make any change in circuit design, specification or other related things if necessary without notice at any time. No third party intellectual property infringement of the applications should be guaranteed by users when integrating Richtek products into any application. No legal responsibility for any said applications is assumed by Richtek.