



Photocoupler Product Data Sheet

4N25/ 4N26

(M, S, S-TA1)

Spec No.: DS-70-99-0010

Effective Date: 12/11/2015

Revision: C

LITE-ON DCC

RELEASE

BNS-OD-FC001/A4

Photocoupler 4N2X Series

1. DESCRIPTION

1.1 Features

- High Current transfer ratio (CTR : MIN. 10% at IF = 10mA, VCE = 10V)
- Response time(ton : TYP. 3μs at VCC = 10V, IC = 2mA, RL = 100Ω)
- Input-output isolation voltage
4N25 series : Viso = 2,500Vrms
4N26 series : Viso = 1,500Vrms
4N27 series : Viso = 1,500Vrms
4N28 series : Viso = 500Vrms
- Dual-in-line package :
4N25, 4N26, 4N27, 4N28
- Wide lead spacing package :
4N25M, 4N26M, 4N27M, 4N28M
- Surface mounting package :
4N25S, 4N26S, 4N27S, 4N28S
- Tape and reel packaging :
4N25S-TA1, 4N26S-TA1, 4N27S-TA1, 4N28S-TA1
- Safety approval
UL approval (NO. E113898)
TUV approval (NO. R9653630)
DEMKO approval (NO. 303985)
CSA & cUL, VDE, FIMKO, CQC approved
- RoHS Compliance
All materials be used in device are followed EU RoHS directive (No.2002/95/EC).
- ESD pass HBM 8000V/MM2000V
- MSL class 1

1.2 Applications

- Hybrid substrates that require high density mounting.
- Programmable controllers

Photocoupler 4N2X Series

2. PACKAGE DIMENSIONS

2.1 4N25

2.2 4N25M

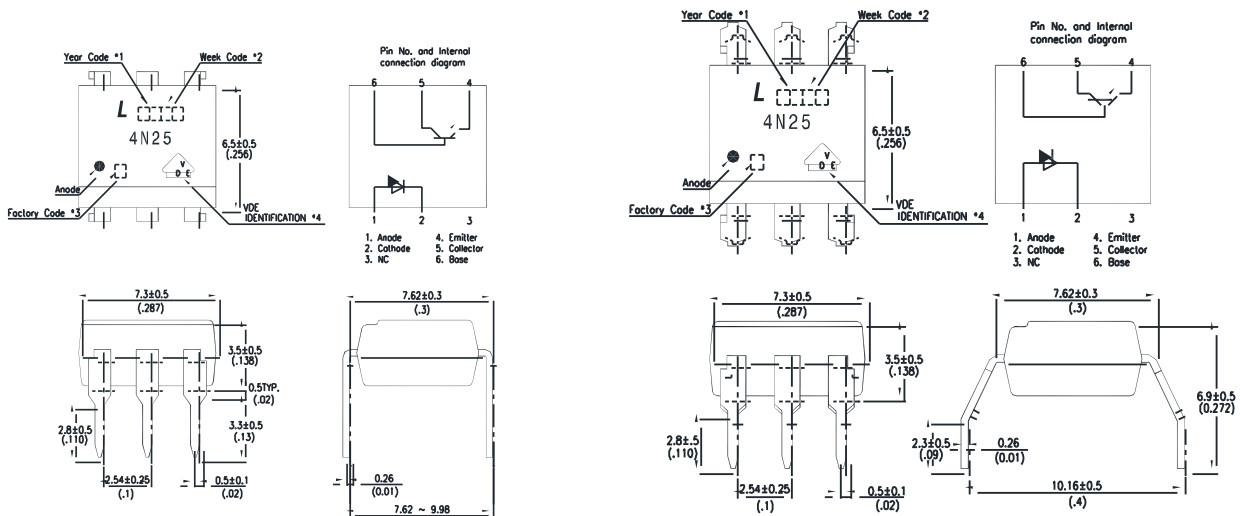

2.3 4N25S

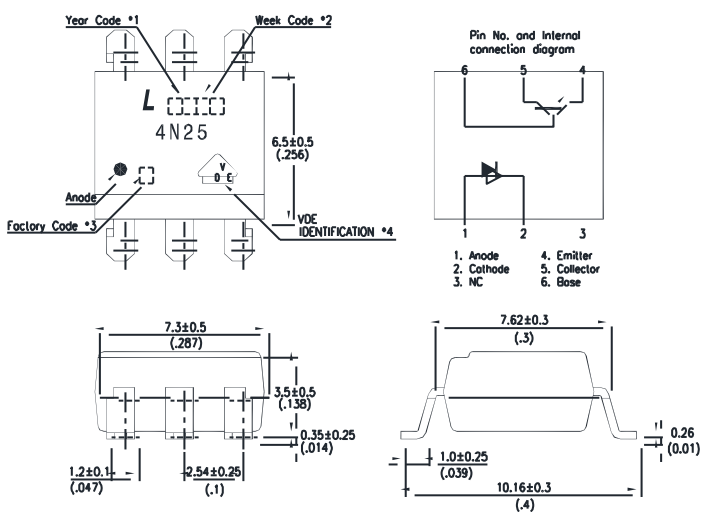

Notes :

1. Year date code.
2. 2-digit work week.
3. Factory identification mark shall be marked (W: China-CZ, Y: Thailand)
4. VDE option.

Dimensions in millimeters(inches).

Photocoupler 4N2X Series

2.4 4N26

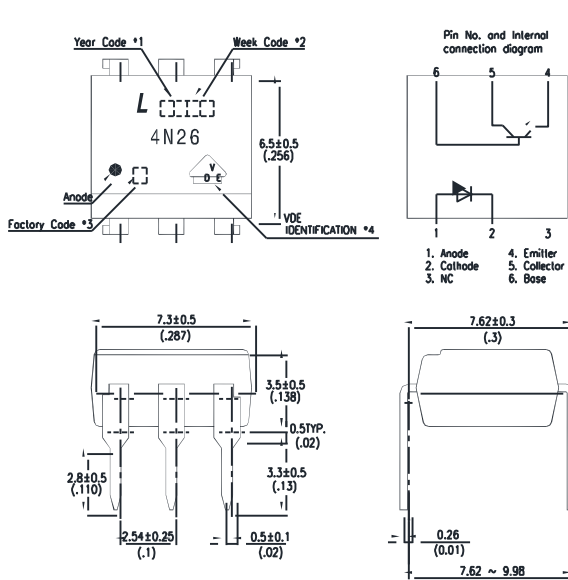

2.5 4N26M

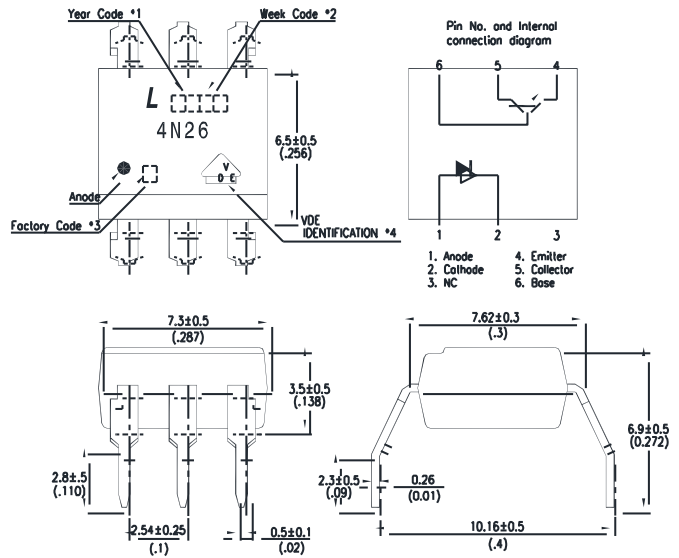

2.6 4N26S

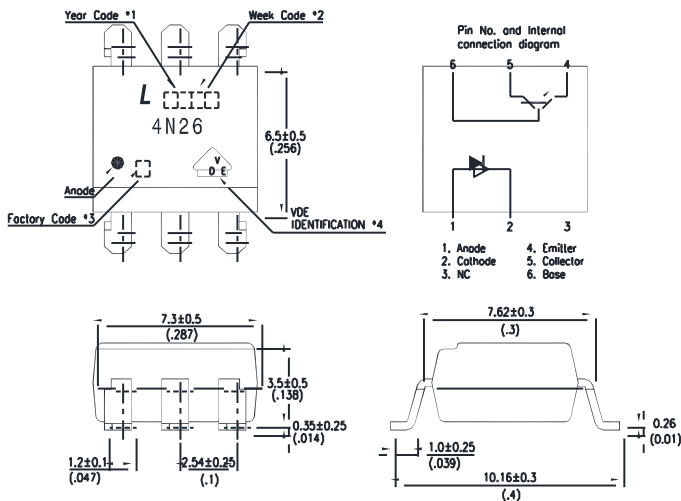

Notes :

1. Year date code.
2. 2-digit work week.
3. Factory identification mark shall be marked (W: China-CZ, Y: Thailand)
4. VDE option.

Dimensions in millimeters(inches).

Photocoupler 4N2X Series

2.7 4N27

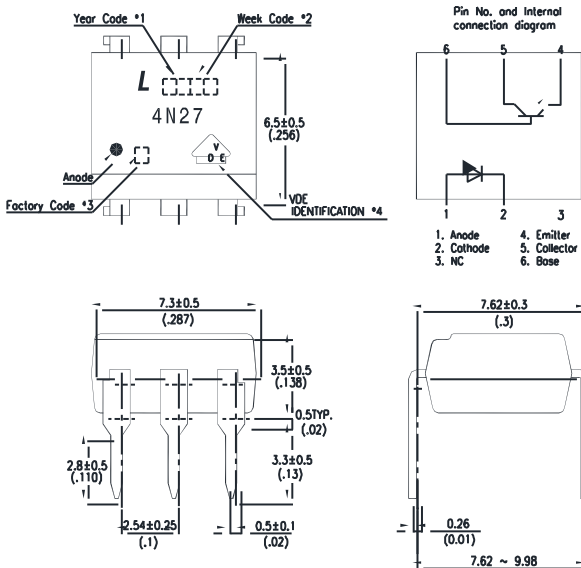

2.8 4N27M

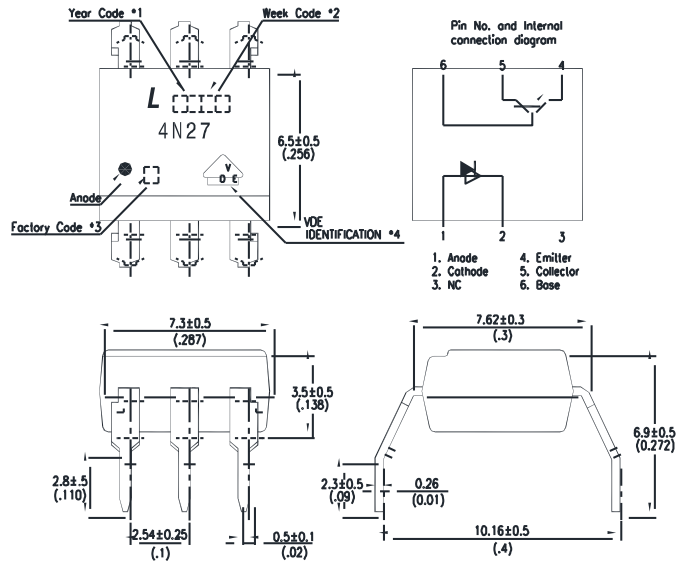

2.9 4N27S

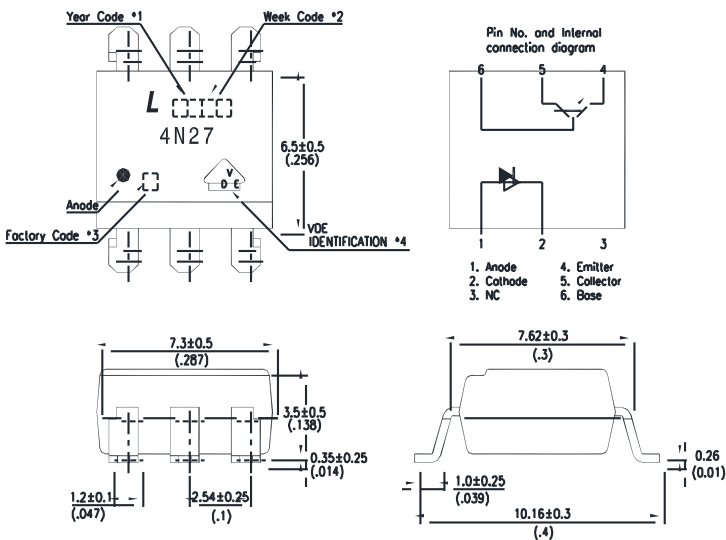

Notes :

1. Year date code.
2. 2-digit work week.
3. Factory identification mark shall be marked (W: China-CZ, Y: Thailand)
4. VDE option.

Dimensions in millimeters(inches).

Photocoupler 4N2X Series

2.10 4N28

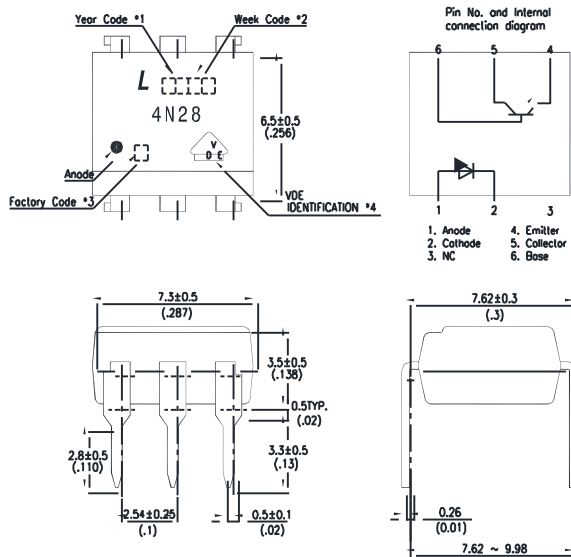

2.11 4N28M

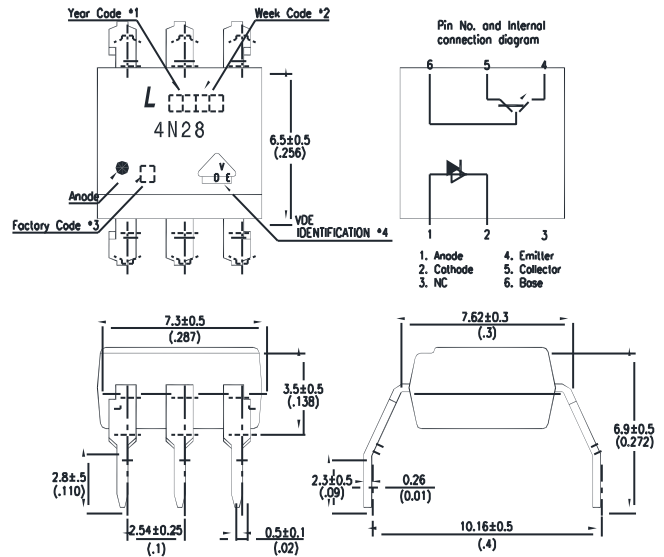

2.12 4N28S

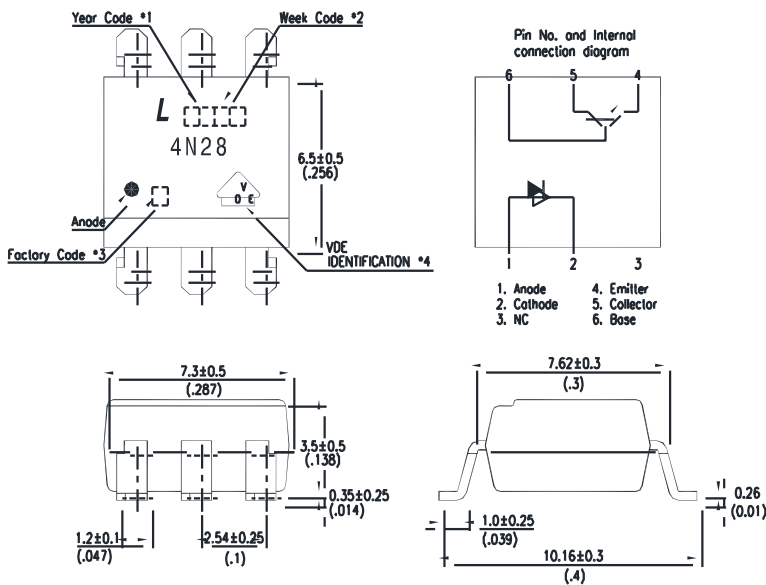

Notes :

1. Year date code.
2. 2-digit work week.
3. Factory identification mark shall be marked (W: China-CZ, Y: Thailand)
4. VDE option.

Dimensions in millimeters(inches).

Photocoupler 4N2X Series

3. TAPING DIMENSIONS

3.1 4N25S-TA , 4N26S-TA , 4N27S-TA , 4N28S-TA

3.2 4N25S-TA1 , 4N26S-TA1 , 4N27S-TA1 , 4N28S-TA1

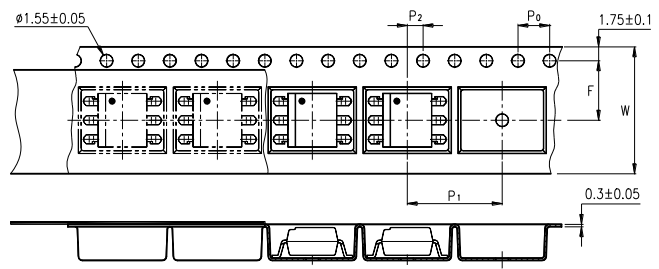
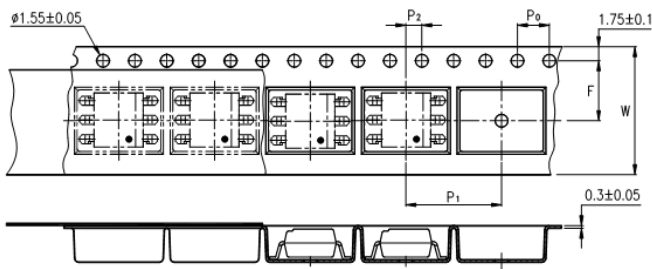

Description	Symbol	Dimension in mm (inch)
Tape wide	W	16±0.3 (0.63)
Pitch of sprocket holes	P ₀	4±0.1 (0.15)
Distance of compartment	F	7.5±0.1 (0.295)
	P ₂	2±0.1 (0.079)
Distance of compartment to compartment	P ₁	12±0.1 (0.472)

3.3 Quantities Per Reel

Package Type	TA/TA1
Quantities (pcs)	1000

**Photocoupler
4N2X Series**

4. RATING AND CHARACTERISTICS

4.1 Absolute Maximum Ratings at Ta=25°C

	Parameter	Symbol	Rating	Unit
Input	Forward Current	I_F	80	mA
	Reverse Voltage	V_R	6	V
	Power Dissipation	P	150	mW
Output	Collector - Emitter Voltage	V_{CEO}	30	V
	Emitter - Collector Voltage	V_{ECO}	7	V
	Collector - Base Voltage	V_{CBO}	70	V
	Collector Current	I_C	100	mA
	Collector Power Dissipation	P_C	150	mW
Total Power Dissipation		P_{tot}	250	mW
*1 Isolation Voltage	4N25 series	V_{iso}	2,500	V_{rms}
	4N26 series		1,500	
	4N27 series		1,500	
	4N28 series		500	
Operating Temperature		T_{opr}	-55 ~ +100	°C
Storage Temperature		T_{stg}	-55 ~ +150	°C
*2 Soldering Temperature		T_{sol}	260	°C

*1. AC For 1 Minute, R.H. = 40 ~ 60%

Isolation voltage shall be measured using the following method.

- (1) Short between anode and cathode on the primary side and between collector and emitter on the secondary side.
- (2) The isolation voltage tester with zero-cross circuit shall be used.
- (3) The waveform of applied voltage shall be a sine wave.

*2. For 10 Seconds

Photocoupler 4N2X Series

4.2 Electrical Optical Characteristics at Ta=25°C

Parameter		Symbol	Min.	Typ.	Max.	Unit	Test Condition
Input	Forward Voltage	V_F	—	1.2	1.5	V	$I_F=10\text{mA}$
	Reverse Current	I_R	—	—	10	μA	$V_R=4\text{V}$
	Terminal Capacitance	C_t	—	50	—	pF	$V=0, f=1\text{KHz}$
Output	Collector Dark Current	I_{CEO}	—	—	50	nA	$V_{CE}=10\text{V}, I_F=0$
	Collector-Emitter Breakdown Voltage	BV_{CEO}	30	—	—	V	$I_C=0.1\text{mA}, I_F=0$
	Emitter-Collector Breakdown Voltage	BV_{ECO}	7	—	—	V	$I_E=10\mu\text{A}, I_F=0$
	Collector-Base Breakdown Voltage	BV_{CBO}	70	—	—	V	$I_C=0.1\text{mA}, I_F=0$
TRANSFER CHARACTERISTICS	Collector Current (4N25/4N26)	I_C	2	—	—	mA	$I_F=10\text{mA}, V_{CE}=10\text{V}$
	* Current Transfer Ratio (4N25/4N26)	CTR	20	—	—	%	
	Collector Current (4N27/4N28)	I_C	1	—	—	mA	
	* Current Transfer Ratio (4N27/4N28)	CTR	10	—	—	%	
	Collector-Emitter Saturation Voltage	$V_{CE(sat)}$	—	0.1	0.5	V	$I_F=50\text{mA}, I_C=2\text{mA}$
	Isolation Resistance	R_{iso}	5×10^{10}	1×10^{11}	—	Ω	DC500V, 40 ~ 60% R.H.
	Floating Capacitance	C_f	—	1	—	pF	$V=0, f=1\text{MHz}$
	Response Time (Rise)	t_r	—	3	—	μs	$V_{CE}=2\text{V}, I_C=2\text{mA}$
	Response Time (Fall)	t_f	—	3	—	μs	$R_L=100\Omega,$

*. Current Transfer Ratio $CTR = \frac{I_C}{I_F} \times 100\%$

Photocoupler 4N2X Series

5. CHARACTERISTICS CURVES

Fig.1 Forward Current vs. Ambient Temperature

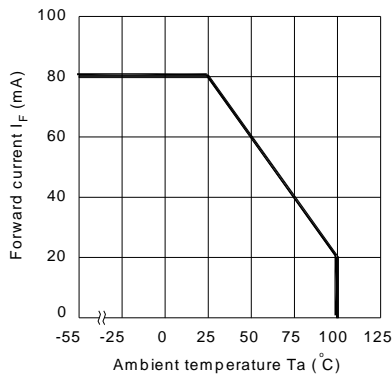

Fig.2 Collector Power Dissipation vs. Ambient Temperature

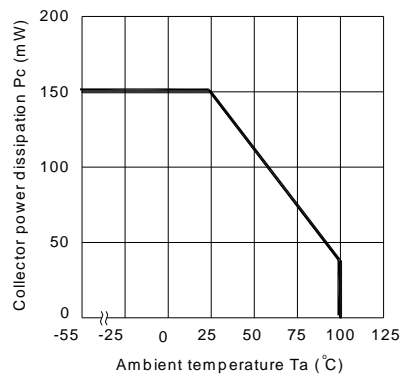

Fig.3 Forward Current vs. Forward Voltage

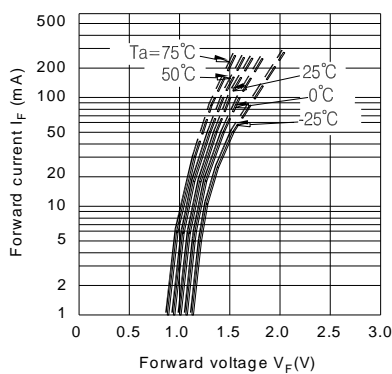

Fig.4 Current Transfer Ratio vs. Forward Current

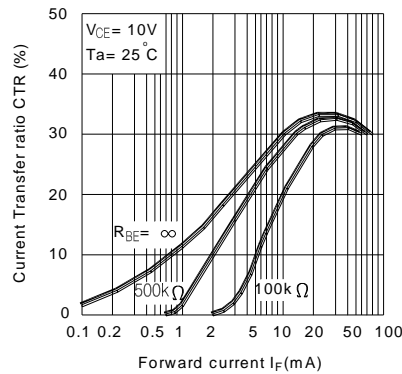

Fig.5 Collector Current vs. Collector-emitter Voltage

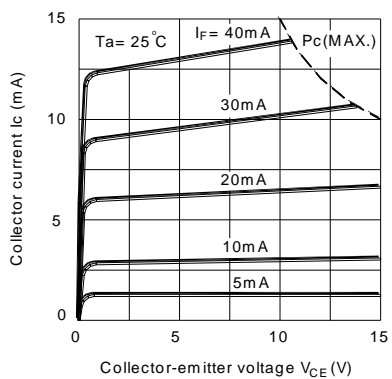
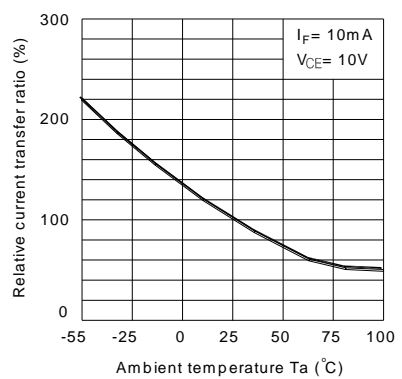

Fig.6 Relative Current Transfer Ratio vs. Ambient Temperature



Photocoupler 4N2X Series

Fig.7 Collector-emitter Saturation Voltage vs. Ambient Temperature

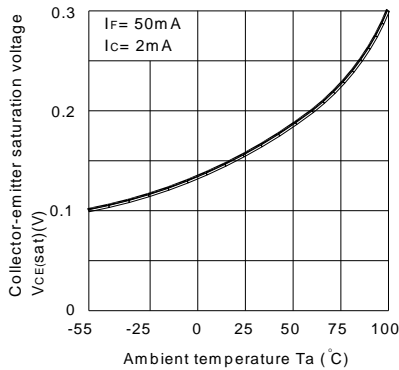

Fig.8 Collector Dark Current vs. Ambient Temperature

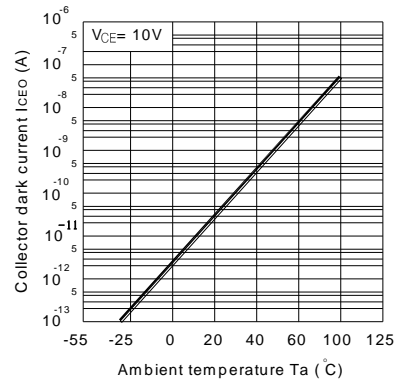

Fig.9 Response Time vs. Load Resistance

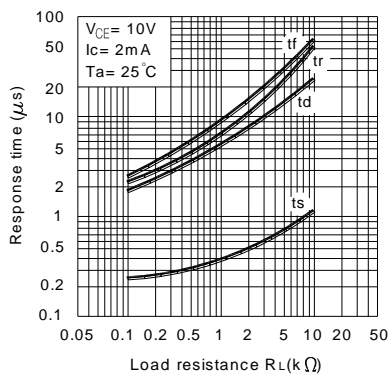

Fig.10 Frequency Response

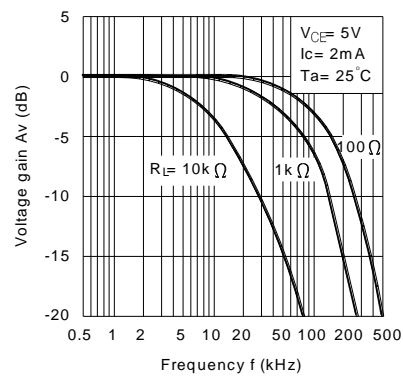
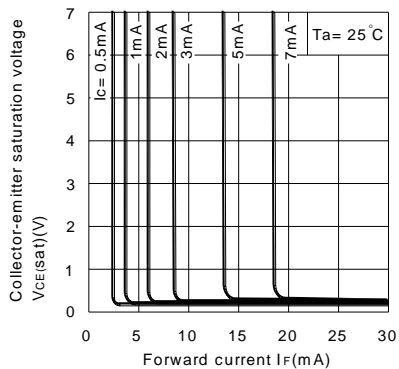
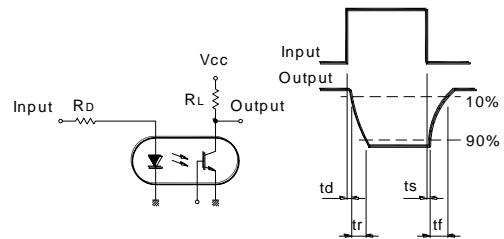

Fig.11 Collector-emitter Saturation Voltage vs. Forward Current



Test Circuit for Response Time



Test Circuit for Frequency Response

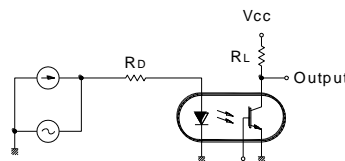

Photocoupler 4N2X Series

6. TEMPERATURE PROFILE OF SOLDERING

6.1 IR Reflow Soldering (JEDEC-STD-020C compliant)

One time soldering reflow is recommended within the condition of temperature and time profile shown below. Do not solder more than three times.

Profile item	Conditions
Preheat	
- Temperature Min (T_{Smin})	150°C
- Temperature Max (T_{Smax})	200°C
- Time (min to max) (ts)	90±30 sec
Soldering zone	
- Temperature (T_L)	217°C
- Time (t_L)	60 sec
Peak Temperature (T_P)	260°C
Ramp-up rate	3°C / sec max.
Ramp-down rate	3~6°C / sec

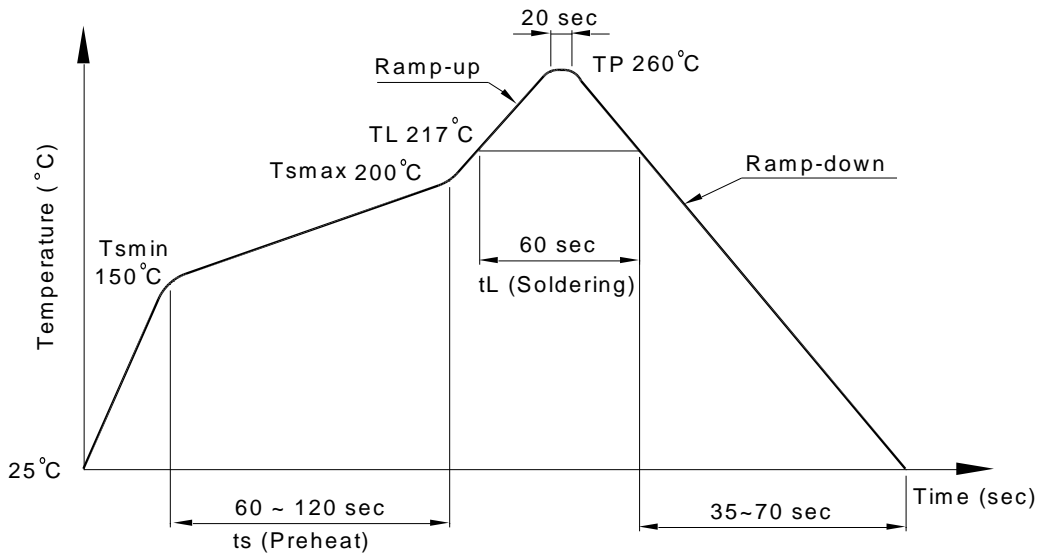

Photocoupler 4N2X Series

6.2 Wave Soldering (JEDEC22A111 compliant)

One time soldering is recommended within the condition of temperature.

Temperature: $260 \pm 0 / -5^{\circ}\text{C}$

Time: 10 sec.

Preheat temperature: 25 to 140°C

Preheat time: 30 to 80 sec.

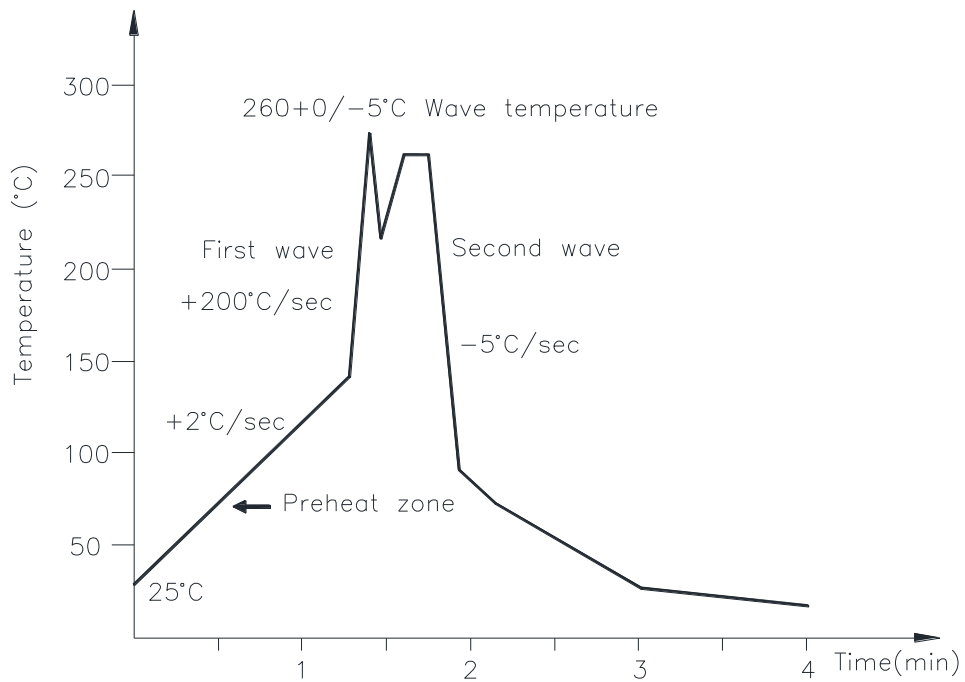

6.3 Hand Soldering by Soldering Iron

Allow single lead soldering in every single process. One time soldering is recommended.

Temperature: $380 \pm 0 / -5^{\circ}\text{C}$

Time: 3 sec max.

**Photocoupler
4N2X Series**

7. RRECOMMENDED FOOT PRINT PATTERNS (MOUNT PAD)

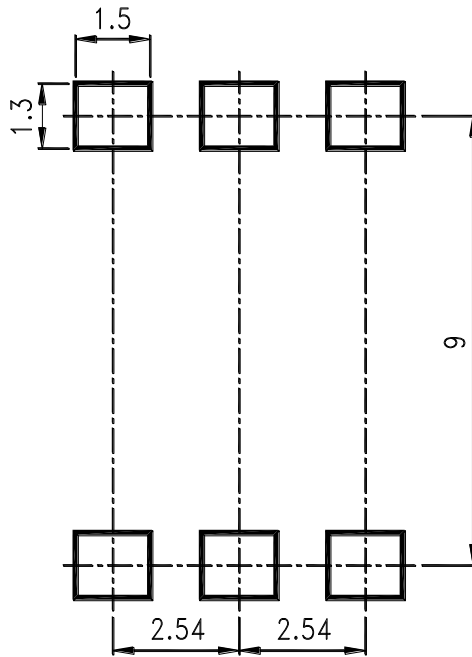

Note :

Dimensions in millimeters.

Photocoupler 4N2X Series

8. Naming rule

4NXX (1)-(2)

DEVICE PART NUMBER

(1) No suffix = Dual-in-Line package

M = Wide lead spacing package

S = Surface mounting package

(2) TAPING TYPE (TA,TA1 or none)

4NXX series have tape and reel solution.

Please refer to orientation of taping on Page P6

Example : 4N25S-TA1

4NXX(1)(2)-V

DEVICE PART NUMBER

(1) No suffix = Dual-in-Line package

M = Wide lead spacing package

S = Surface mounting package

(2) TAPING TYPE (TA,TA1 or none)

4NXX series have tape and reel solution.

Please refer to orientation of taping on Page P6

(3) VDE order option

Example : 4N25STA1-V-G

9. Notes:

- LiteOn is continually improving the quality, reliability, function or design and LiteOn reserves the right to make changes without further notices.
- The products shown in this publication are designed for the general use in electronic applications such as office automation equipment, communications devices, audio/visual equipment, electrical application and instrumentation.
- For equipment/devices where high reliability or safety is required, such as space applications, nuclear power control equipment, medical equipment, etc, please contact our sales representatives.
- When requiring a device for any "specific" application, please contact our sales in advance.
- If there are any questions about the contents of this publication, please contact us at your convenience.
- The contents described herein are subject to change without prior notice.
- Immerring unit's body in solder paste is not recommended.