

# SMT Air Coil Inductor

AIAC-1008C

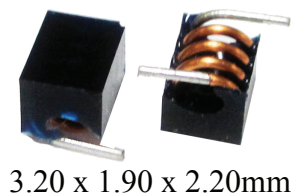

**RoHS**  
Compliant



3.20 x 1.90 x 2.20mm

## FEATURES:

- High current design
- Wide Range Frequency Response
- Excellent Q & SRF
- Standard flat cap top suitable for automatic placement.

## APPLICATIONS:

- Widely used in Cordless Phones, High Frequency Communication Equipments, Intercom, CATV, RFID
- Suitable for metal sensors and proximity sensors
- Noise suppression for RF power supply/bias
- I/O filtering, frequency selection for audio devices such as Loudspeakers, Hifi
- Impedance Matching for transceivers
- Improves switch isolation for RF circuit

## STANDARD SPECIFICATIONS:

PARAMETERS	
ABRACON P/N:	AIAC-1008C
Operating temperature:	-40 °C ~ +125 °C
Storage temperature:	-25°C to + 60°C

Part Number	Inductance	Tolerance	DCR (Max)	Q(Min)	SRF(Min)	Rated Current (Max)	Inductance Code
Units	nH	%	mΩ		MHz	mA	
Symbol	L	K	DCR			IDC	
AIAC-1008C-6N8	6.8	K	4.0	80	>3000	1200	6N8
AIAC-1008C-8N2	8.2	K	5.0	80	>3000	950	8N2
AIAC-1008C-10N	10	K	6.0	70	>3000	950	10N
AIAC-1008C-12N	12	K	6.5	70	>3000	900	12N
AIAC-1008C-15N	15	K	7.3	70	2500	900	15N
AIAC-1008C-18N	18	K	9.6	70	2500	840	18N
AIAC-1008C-22N	22	K	10.8	70	2400	840	22N
AIAC-1008C-27N	27	K	13.9	70	1600	600	27N
AIAC-1008C-33N	33	K	19.5	70	1600	500	33N
AIAC-1008C-39N	39	K	21.6	70	1500	500	39N
AIAC-1008C-47N	47	K	25.2	70	1500	470	47N
AIAC-1008C-56N	56	K	27.5	70	1300	470	56N
AIAC-1008C-68N	68	K	37.1	70	1300	380	68N
AIAC-1008C-82N	82	K	51.5	70	1000	320	82N
AIAC-1008C-R10	100	K	55.5	70	1000	320	R10
AIAC-1008C-R12	120	K	63.4	70	950	320	R12

## Test Conditions and equipments

Test frequency: 300MHz

Equipment: HP4286A/HP16191A

## PART IDENTIFICATION:

AIAC-1008C- [ ] [ ] - [ ]

### Inductance Code

Please refer to the Electrical Spec Table

### Tolerance

K: ±10%

### Packaging

T: Tape and Reel (3kpcs / reel)

# SMT Air Coil Inductor

AIAC-1008C



**RoHS**  
Compliant

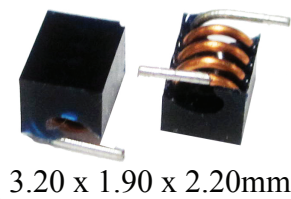

3.20 x 1.90 x 2.20mm

## OUTLINE DRAWING:

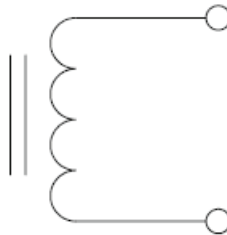
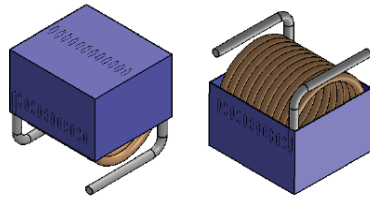
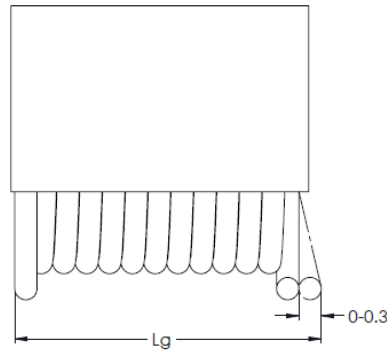
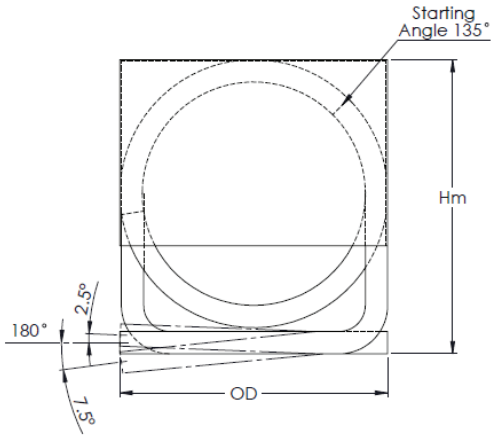

<b>Hm</b>	2.20 Max
<b>OD</b>	1.90 Max
<b>Lg</b>	3.20 Max

## Recommended Land Pattern

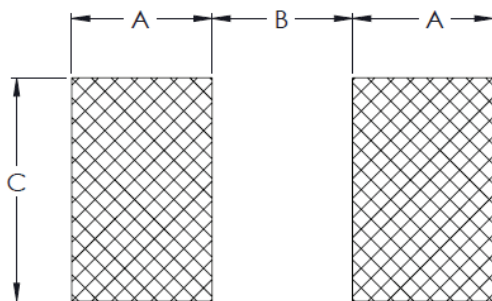

<b>A</b>	1.02 Min
<b>B</b>	1.27 Min
<b>C</b>	2.54 Min

Dimension: mm

# SMT Air Coil Inductor

AIAC-1008C



RoHS  
Compliant

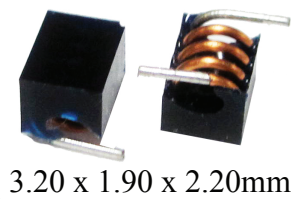

3.20 x 1.90 x 2.20mm

## REFLOW PROFILE:

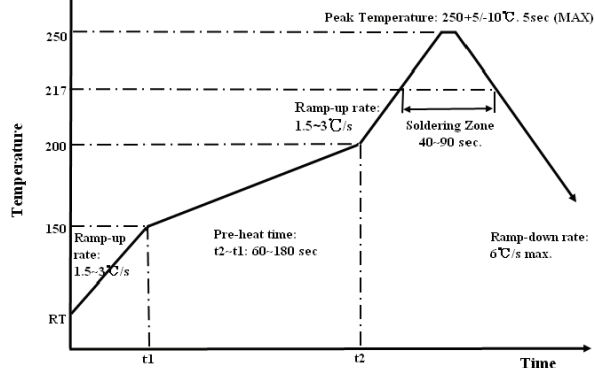

## TAPE & REEL:

### Packing

T: 3,000pcs / reel

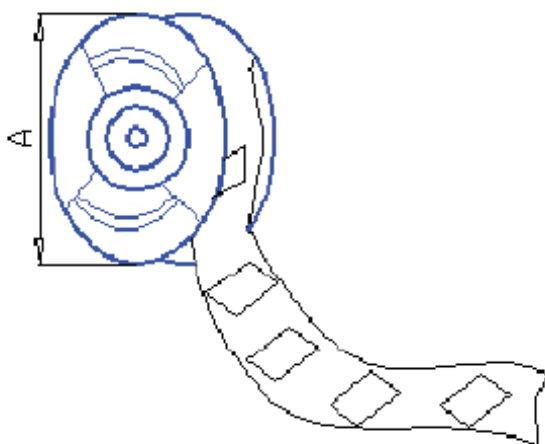
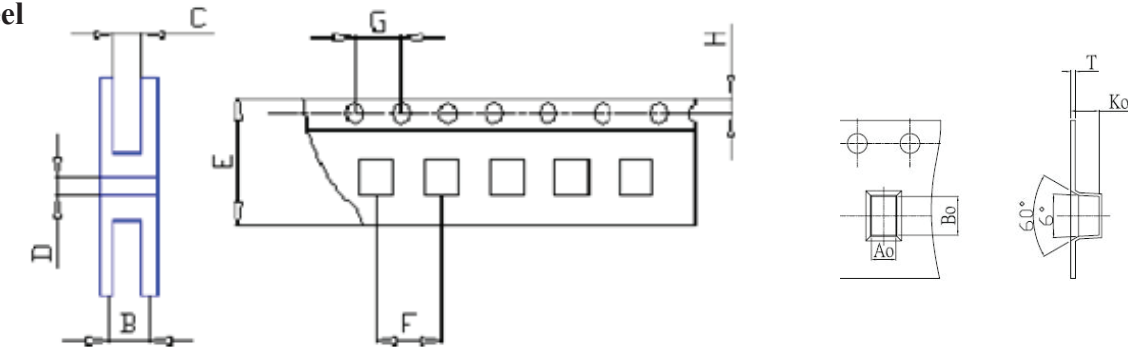

Ao	2.3±0.10
Bo	3.4±0.10
Ko	2.3±0.10
A	330
B	18
C	12
D	13
E	12
F	8.0
G	4.0
H	1.75
T	0.35

Dimension: mm

**ATTENTION:** Abracon Corporation's products are COTS – Commercial-Off-The-Shelf products; suitable for Commercial, Industrial and, where designated, Automotive Applications. Abracon's products are not specifically designed for Military, Aviation, Aerospace, Life-dependant Medical applications or any application requiring high reliability where component failure could result in loss of life and/or property. For applications requiring high reliability and/or presenting an extreme operating environment, written consent and authorization from Abracon Corporation is required. Please contact Abracon Corporation for more information.

ABRACON IS  
ISO 9001:2008  
CERTIFIED



Visit [www.abracon.com](http://www.abracon.com) for Terms & Conditions of Sale  
30332 Esperanza, Rancho Santa Margarita, California 92688  
tel 949-546-8000 | fax 949-546-8001 | [www.abracon.com](http://www.abracon.com)

Revised: 11.20.12