

**Features**

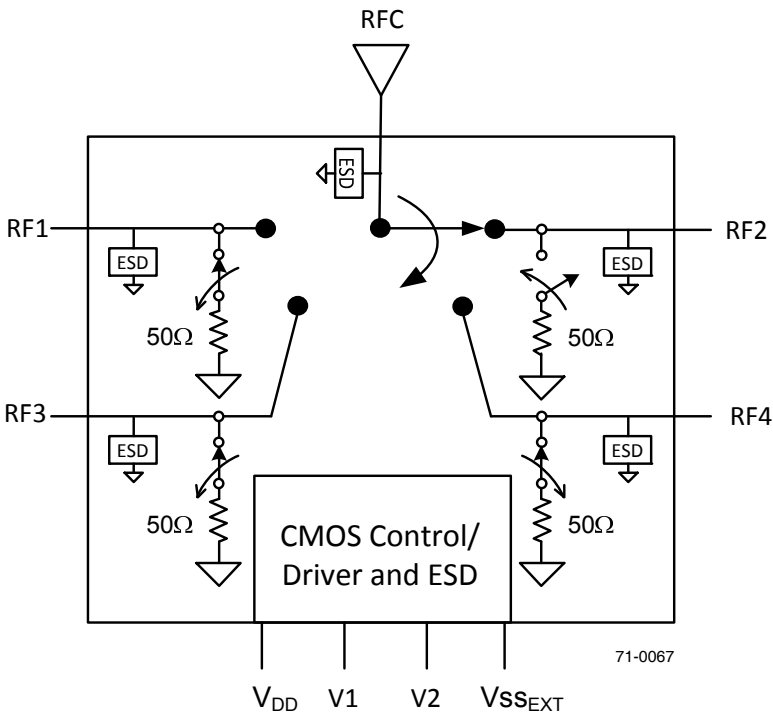
- HaRP™ technology enhanced
  - Fast settling time
  - Eliminates gate and phase lag
  - No drift in insertion loss and phase
- High linearity: 58 dBm IIP3
- Low insertion loss: 0.8 dB @ 3 GHz, 1.0 dB @ 6 GHz and 1.2 dB @ 8 GHz
- High isolation: 45 dB @ 3 GHz, 39 dB @ 6 GHz and 31 dB @ 8 GHz
- Maximum power handling: 30 dBm @ 8 GHz
- High ESD tolerance of 2 kV HBM on RFC and 1 kV HBM on all other pins

**Product Description**

The PE42540 is a HaRP™ technology-enhanced absorptive SP4T RF switch developed on UltraCMOS® process technology. This switch is designed specifically to support the requirements of the test equipment and ATE market. It is comprised of four symmetric RF ports and has very high isolation. An on-chip CMOS decode logic facilitates a two-pin low voltage CMOS control interface and an optional external V<sub>SS</sub> feature. High ESD tolerance and no blocking capacitor requirements make this the ultimate in integration and ruggedness.

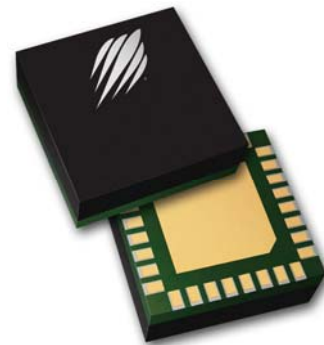
The PE42540 is manufactured on Peregrine's UltraCMOS® process, a patented variation of silicon-on-insulator (SOI) technology on a sapphire substrate, offering the performance of GaAs with the economy and integration of conventional CMOS.

**Figure 1. Functional Diagram**



**Figure 2. Package Type**

32-lead 5x5 mm LGA



**Table 1. Electrical Specifications @ 25°C, V<sub>DD</sub> = 3.3V, V<sub>SS</sub>EXT = 0V (Z<sub>S</sub> = Z<sub>L</sub> = 50Ω)**

Parameter	Condition	Min	Typ	Max	Unit
Operating Frequency		10 Hz <sup>1</sup>		8 GHz	
RFC–RFX Insertion Loss	10 Hz–9 kHz		0.7	1.0	dB
	3000 MHz		0.8	1.1	dB
	6000 MHz		1.0	1.3	dB
	7500 MHz		1.1	1.5	dB
	8000 MHz		1.2	1.6	dB
RFX–RFX Isolation	10 Hz–9 kHz	70	80		dB
	3000 MHz	40	45		dB
	6000 MHz	34	39		dB
	7500 MHz	27	32		dB
	8000 MHz	25	31		dB
RFC–RFX Isolation	10 Hz–9 kHz	74	84		dB
	3000 MHz	40	45		dB
	6000 MHz	28	33		dB
	7500 MHz	24	29		dB
	8000 MHz	21	27		dB
Return Loss (RFC to active port)	10 Hz–9 kHz		24		dB
	3000 MHz		23		dB
	6000 MHz		18		dB
	7500 MHz		14		dB
	8000 MHz		13		dB
Return Loss (terminated port)	10 Hz–9 kHz		35		dB
	3000 MHz		18		dB
	6000 MHz		13		dB
	7500 MHz		11		dB
	8000 MHz		10		dB
Settling Time	50% CTRL to 0.05dB final value (–40 to +85°C) <i>Rising Edge</i>		14	18	μs
	50% CTRL to 0.05dB final value (–40 to +85°C) <i>Falling Edge</i>		15	45	μs
Switching Time (T <sub>sw</sub> )	50% CTRL to 90% or 10% RF		5	8	μs
P1dB <sup>1</sup> Input 1 dB Compression RFX–RFC	All bands @ 1:1 VSWR, 100% duty cycle	31	33		dBm
Input IP3	8000 MHz		58		dBm
Input IP2	8000 MHz		100		dBm

Note 1: Maximum Operating Pin (50Ω) is shown in Table 3. Please refer to Figures 4, 5, and 6 when operating the part at low frequency

Figure 3. Pin Configuration (Top View)

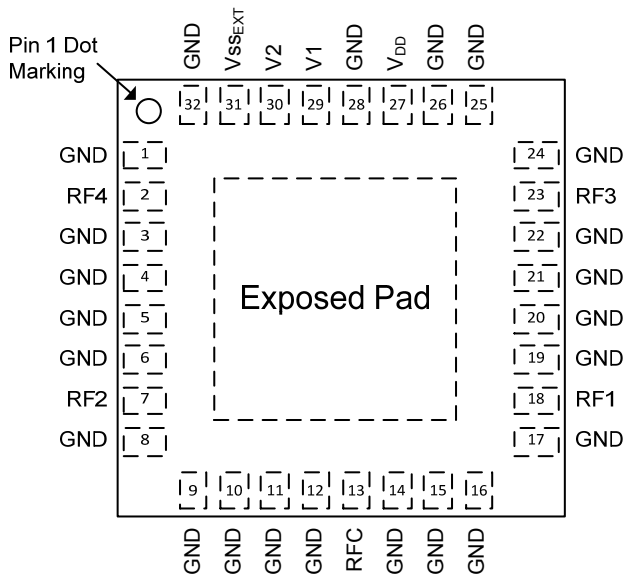


Table 2. Pin Descriptions

Pin #	Pin Name	Description
1, 3-6, 8, 9-12, 14-17, 19-22, 24-26, 28, 32	GND	Ground
2	RF4 <sup>2</sup>	RF I/O
7	RF2 <sup>2</sup>	RF I/O
13	RFC <sup>2</sup>	RF Common
18	RF1 <sup>2</sup>	RF I/O
23	RF3 <sup>2</sup>	RF I/O
27	V <sub>DD</sub>	Supply
29	V1	Switch control input, CMOS logic level
30	V2	Switch control input, CMOS logic level
31	V <sub>SS_EXT</sub> <sup>1</sup>	External V <sub>SS</sub> Negative Voltage
Paddle	GND	Exposed solder pad: Ground for proper operation

Notes: 1. Use V<sub>SS\_EXT</sub> (pin 31, V<sub>SS\_EXT</sub> = -V<sub>DD</sub>) to bypass and disable internal negative voltage generator. Connect V<sub>SS\_EXT</sub> (pin 31) to GND (V<sub>SS\_EXT</sub> = 0V) to enable internal negative voltage generator  
2. All RF pins must be DC blocked with an external series capacitor or held at 0 VDC

Table 3. Operating Ranges

Parameter	Min	Typ	Max	Unit
V <sub>DD</sub> Supply Voltage	3.0	3.3	3.55	V
V <sub>SS_EXT</sub> Negative Power Supply Voltage <sup>1</sup>	-3.6	-3.3	-3.0	V
I <sub>SS</sub> Negative Supply Current		-10	-40	μA
I <sub>DD</sub> Power Supply Current V <sub>DD</sub> = 3.3V, V <sub>SS_EXT</sub> = 0V, Temp = +85°C		90	160	μA
I <sub>DD</sub> Power Supply Current V <sub>DD</sub> = 3.6V, V <sub>SS_EXT</sub> used			50	μA
V <sub>CTRL</sub> Control Voltage High	1.2	1.5	V <sub>DD</sub>	V
V <sub>CTRL</sub> Control Voltage Low	0	0	0.4	V
I <sub>CTRL</sub> Control Current			1	μA
P <sub>IN</sub> Thru Path <sup>2</sup> (50Ω, RF Power in) 9 kHz – 8 GHz			figs. 4,5,6	
P <sub>max</sub> Max power into termination (50Ω) 9 kHz ≤ 6 MHz <sup>2,3</sup> 6 MHz – 8 GHz <sup>2,3</sup>			figs. 4,5,6 20	dBm
P <sub>max</sub> Max power, hot switching (50Ω) 9 kHz ≤ 6 MHz <sup>2,3</sup> 6 MHz – 8 GHz <sup>2,3</sup>			figs. 4,5,6 20	dBm
T <sub>OP</sub> Operating temperature range	-40		+85	°C

Notes: 1. Applies only when external V<sub>SS</sub> power supply is used. Otherwise, V<sub>SS\_EXT</sub> = 0  
2. 100% duty cycle (-40 to +85°C, 1:1 VSWR)  
3. Do not exceed 20 dBm

**Table 4. Absolute Maximum Ratings**

Parameter/Condition	Min	Max	Unit
T <sub>ST</sub> Storage temperature range	-60	+150	°C
V <sub>DD</sub> Supply Voltage	-0.3	4	V
V <sub>CTRL</sub> Control Voltage, V1 and V2		4	V
P <sub>IN</sub> Thru Path (50Ω, RF Power in) 9 kHz – 8 GHz		<i>figs.</i> 4,5,6	
P <sub>max</sub> Max power into termination (50Ω) 9 kHz ≤ 6 MHz <sup>1</sup> 6 MHz – 8 GHz		<i>figs.</i> 4,5,6 20	  dBm
V <sub>ESD</sub> ESD Voltage HBM <sup>2</sup> RFC All Pins		2000 1000	V V
V <sub>ESD</sub> ESD Voltage MM, all pins <sup>3</sup>		100	V

Notes: 1. Do not exceed 20 dBm  
2. HBM, MIL-STD 883 Method 3015.7  
3. MM JEDEC JESD22-A115-A

Exceeding absolute maximum ratings may cause permanent damage. Operation should be restricted to the limits in the Operating Ranges table. Operation between operating range maximum and absolute maximum for extended periods may reduce reliability.

### Electrostatic Discharge (ESD) Precautions

When handling this UltraCMOS<sup>®</sup> device, observe the same precautions that you would use with other ESD-sensitive devices. Although this device contains circuitry to protect it from damage due to ESD, precautions should be taken to avoid exceeding the specified rating.

### Latch-Up Avoidance

Unlike conventional CMOS devices, UltraCMOS<sup>®</sup> devices are immune to latch-up.

### Switching Frequency

The PE42540 has a maximum 25 kHz switching rate when the internal negative voltage generator is used (pin 31 = GND). The rate at which the PE42540 can be switched is only limited to the switching time (*Table 1*) if an external negative supply is provided at (pin 31 = V<sub>SSEXT</sub>).

### Optional External V<sub>SS</sub> Control (V<sub>SSEXT</sub>)

For proper operation, the V<sub>SSEXT</sub> control pin must be grounded or tied to the V<sub>SS</sub> voltage specified in *Table 3*. When the V<sub>SSEXT</sub> control pin is grounded, FETs in the switch are biased with an internal voltage generator. For applications that require the lowest possible spur performance, V<sub>SSEXT</sub> can be applied externally to bypass the internal negative voltage generator.

### Spurious Performance

The typical spurious performance of the PE42540 is -144 dBm when V<sub>SSEXT</sub> = 0V (pin 31 = GND). If further improvement is desired, the internal negative voltage generator can be disabled by setting V<sub>SSEXT</sub> = -V<sub>DD</sub>.

**Table 5. Truth Table**

State	V1	V2
RF1 on	0	0
RF2 on	1	0
RF3 on	0	1
RF4 on	1	1

### Moisture Sensitivity Level

The Moisture Sensitivity Level rating for the PE42540 in the 32-lead 5x5 mm LGA package is MSL3.

## Low Frequency Operation

Table 6 shows the minimum and maximum voltage limits when operating the device under various  $V_{DD}$  and  $V_{SS_{EXT}}$  voltage conditions below 9 kHz. Refer to Figures 4, 5, and 6 to determine the maximum operating power over the frequency range of the device.

**Table 6. Instantaneous RF Pin Voltage Limits for Operation Below 9 kHz**

$V_{DD}$	$V_{SS_{EXT}}$	Minimum Peak Voltage at RF Port	Maximum Peak Voltage at RF Port
$\geq 3.0$	0.0	-0.2	1.2
3.0	-3.0	-0.6	1.6
3.3	-3.3	-0.3	1.3
3.5	-3.5	-0.1	1.1
3.6	-3.6	0.0	1.0

## Maximum Operating Power vs. Frequency

Figures 4, 5, and 6 show the power limit of the device will increase with frequency. As the frequency increases, the contours and maximum power limit will increase as shown in the curves.

Figure 4. Maximum Operating Power vs. Frequency ( $T_{\text{ambient}} = 25^{\circ}\text{C}$ )

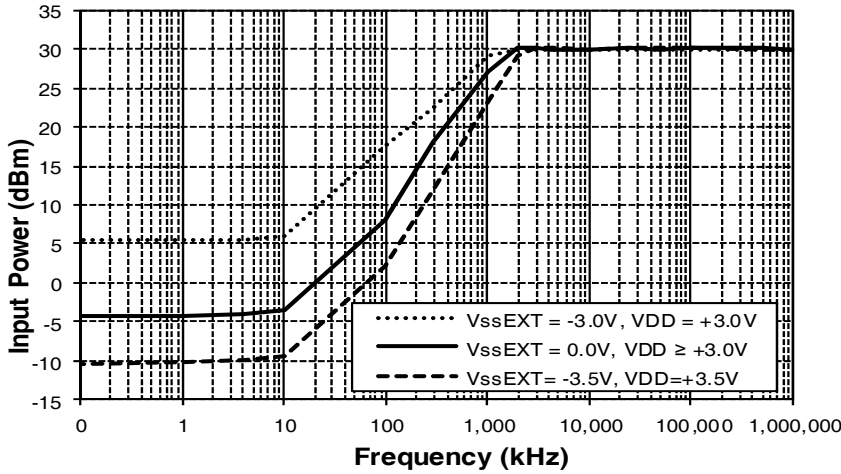


Figure 5. Maximum Operating Power vs. Frequency ( $T_{\text{ambient}} = 50^{\circ}\text{C}$ )

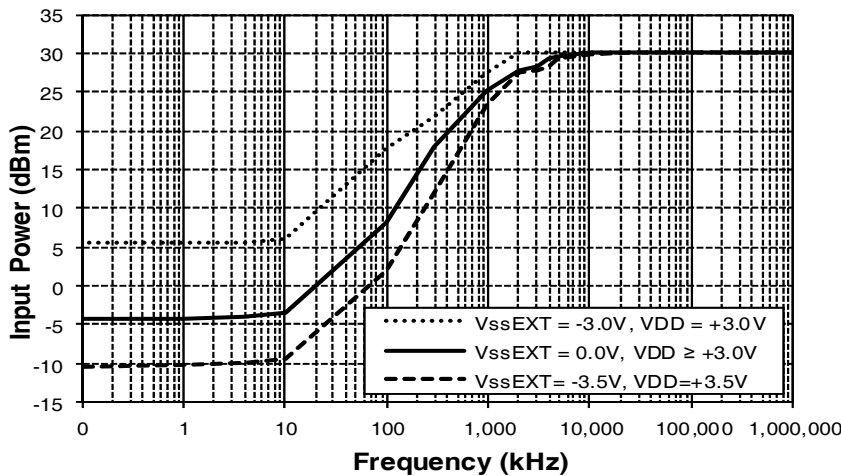
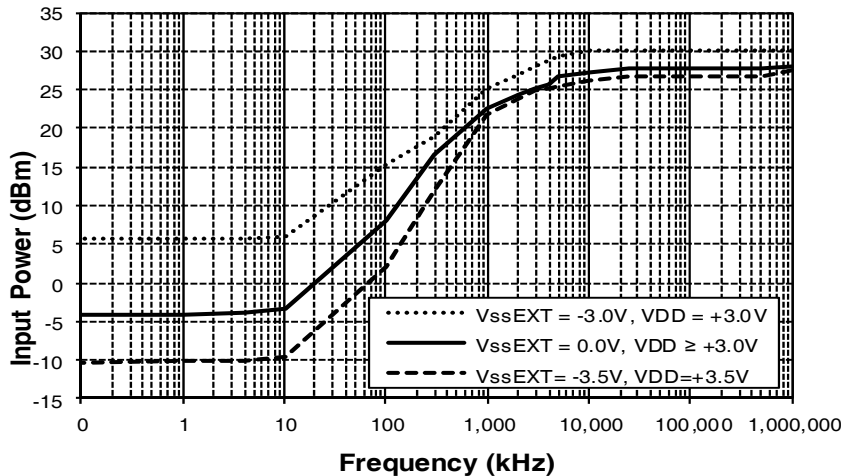
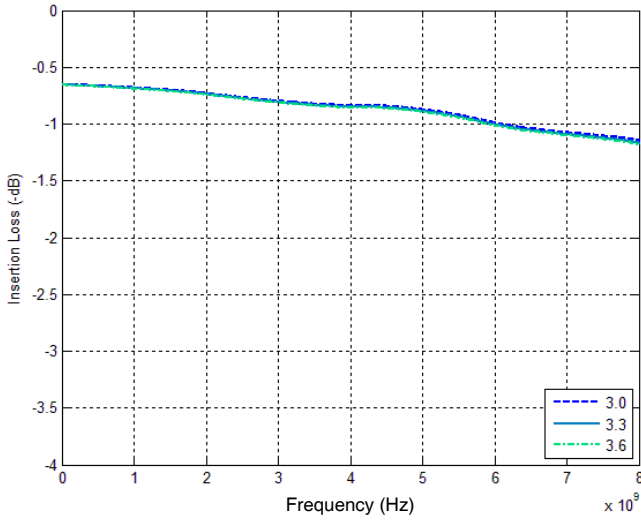


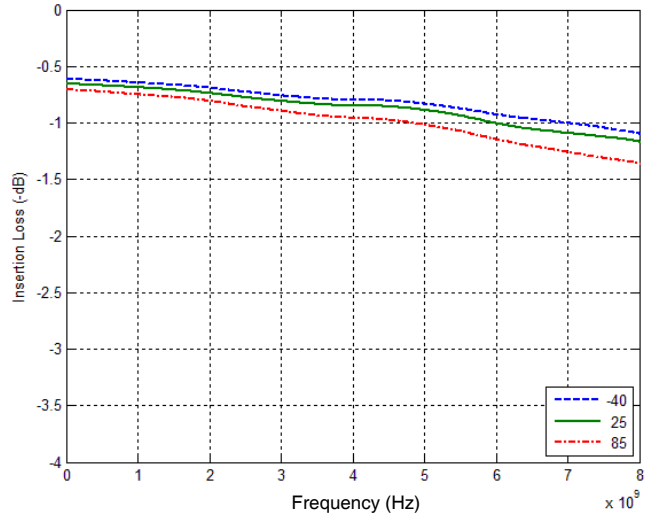
Figure 6. Maximum Operating Power vs. Frequency ( $T_{\text{ambient}} = 85^{\circ}\text{C}$ )



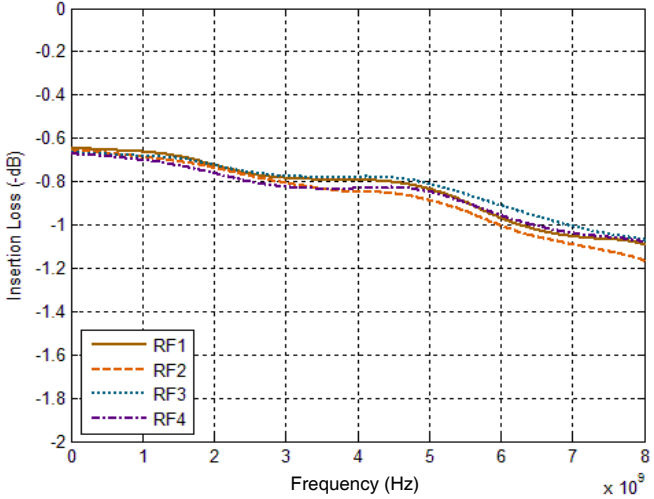
**Figure 7. Insertion Loss vs.  $V_{DD}$**   
(Temp = 25°C,  $V_{SS} = 0$ )



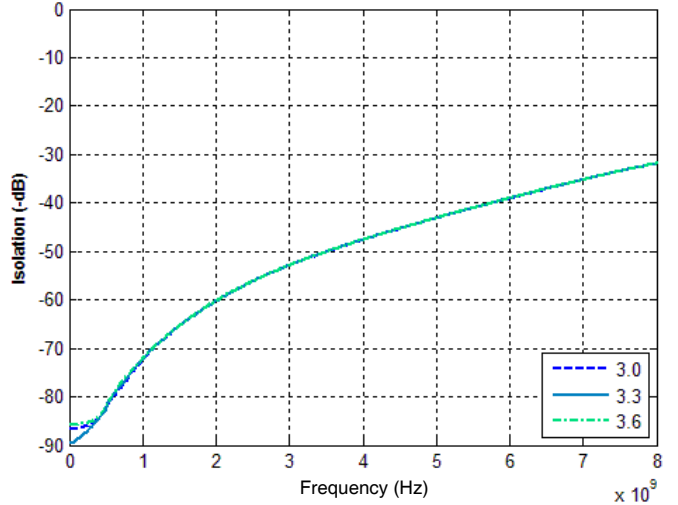
**Figure 8. Insertion Loss vs. Temp**  
( $V_{DD} = 3.3V$ ,  $V_{SS} = 0$ )



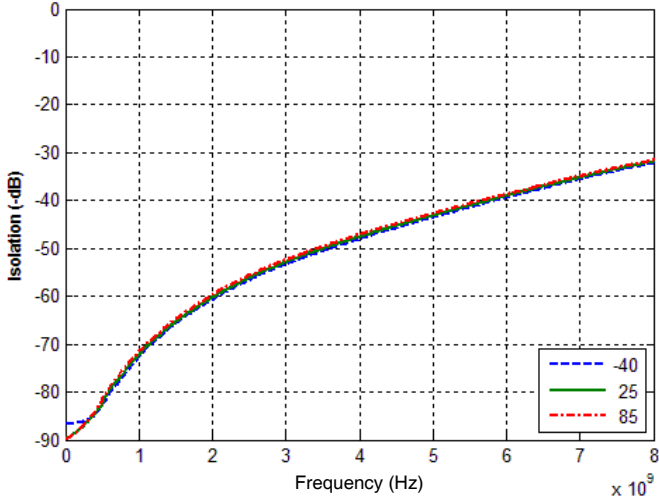
**Figure 9. Insertion Loss**  
(Temp = 25°C,  $V_{DD} = 3.3V$ ,  $V_{SS} = 0$ )



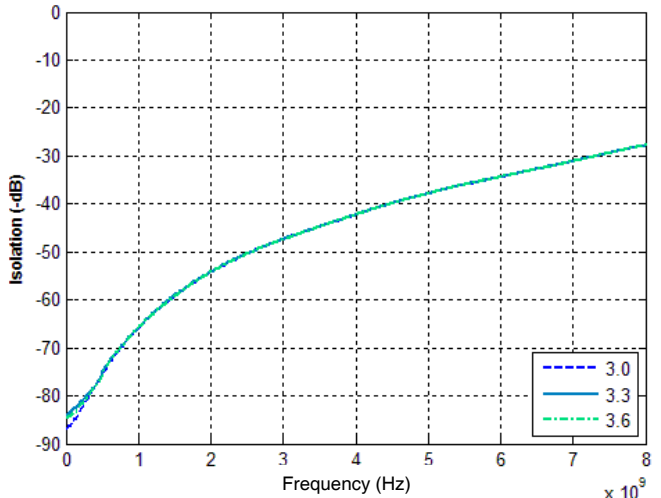
**Figure 10. Isolation: RFX-RFX vs.  $V_{DD}$**   
(Temp = 25°C,  $V_{SS} = 0$ )



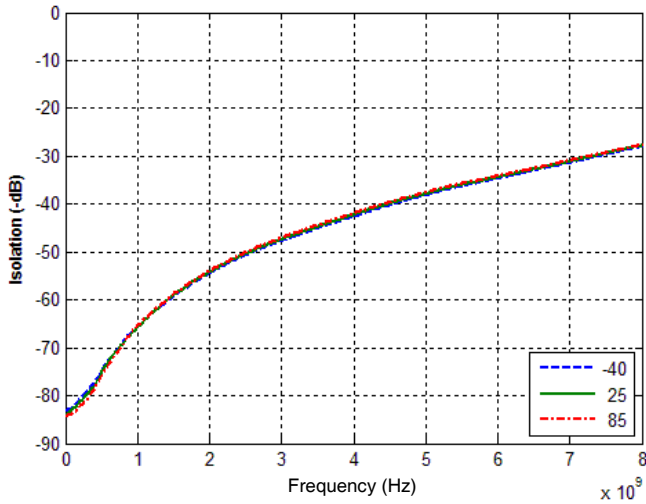
**Figure 11. Isolation: RFX-RFX vs. Temp**  
( $V_{DD} = 3.3V$ ,  $V_{SS} = 0$ )



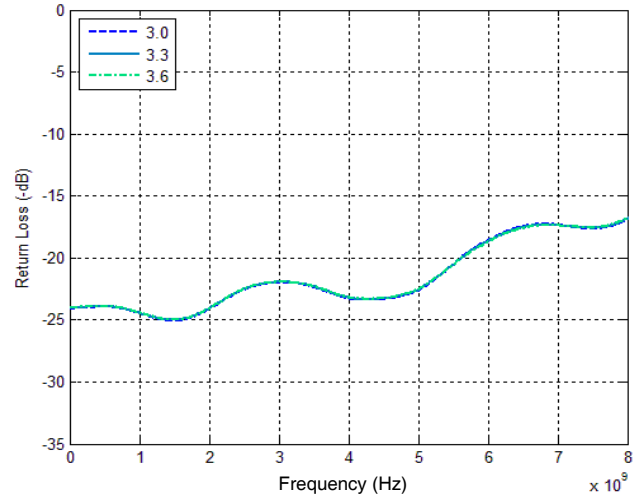
**Figure 12. Isolation: RFX-RFC vs.  $V_{DD}$**   
(Temp = 25°C,  $V_{SS} = 0$ )



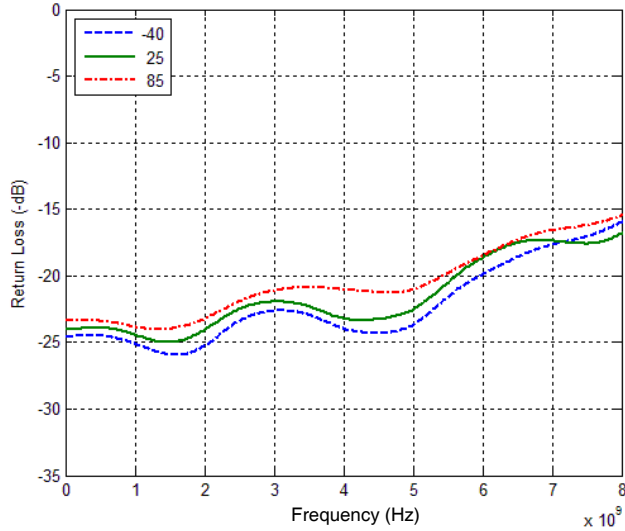
**Figure 13. Isolation: RFX-RFC vs. Temp**  
( $V_{DD} = 3.3V$ ,  $V_{SS} = 0$ )



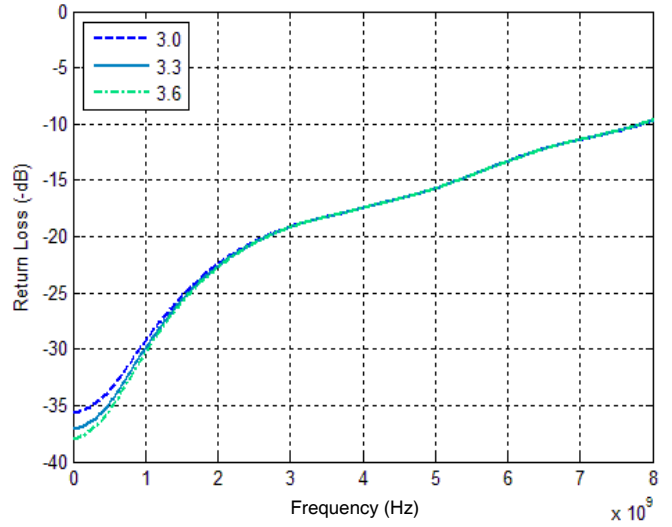
**Figure 14. Active Port Return Loss vs.  $V_{DD}$**   
(Temp = 25°C,  $V_{SS} = 0$ )



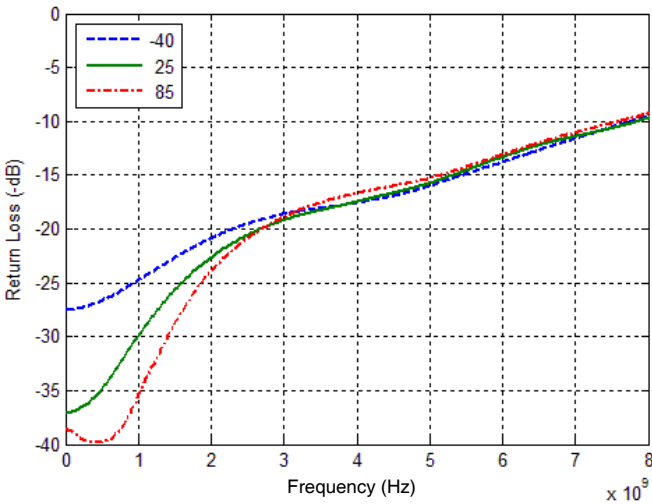
**Figure 15. Active Port Return Loss vs. Temp**  
( $V_{DD} = 3.3V$ ,  $V_{SS} = 0$ )



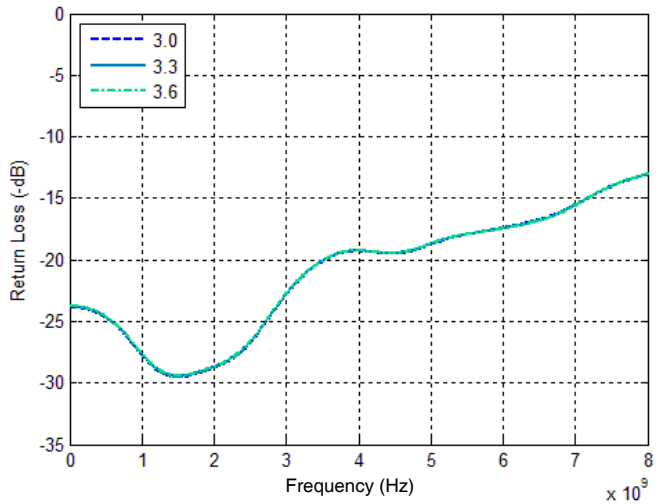
**Figure 16. Terminated Port Return Loss vs.  $V_{DD}$**   
(Temp = 25°C,  $V_{SS} = 0$ )



**Figure 17. Terminated Port Return Loss vs. Temp**  
( $V_{DD} = 3.3V$ ,  $V_{SS} = 0$ )

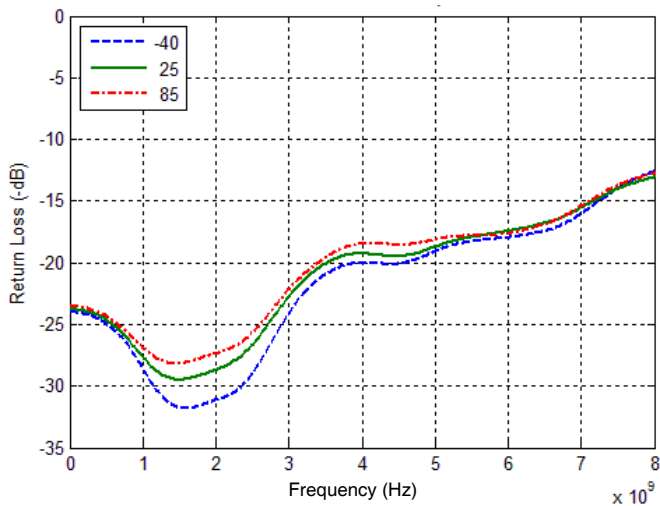


**Figure 18. RFC Port Return Loss vs.  $V_{DD}$**   
(Temp = 25°C,  $V_{SS} = 0$ )

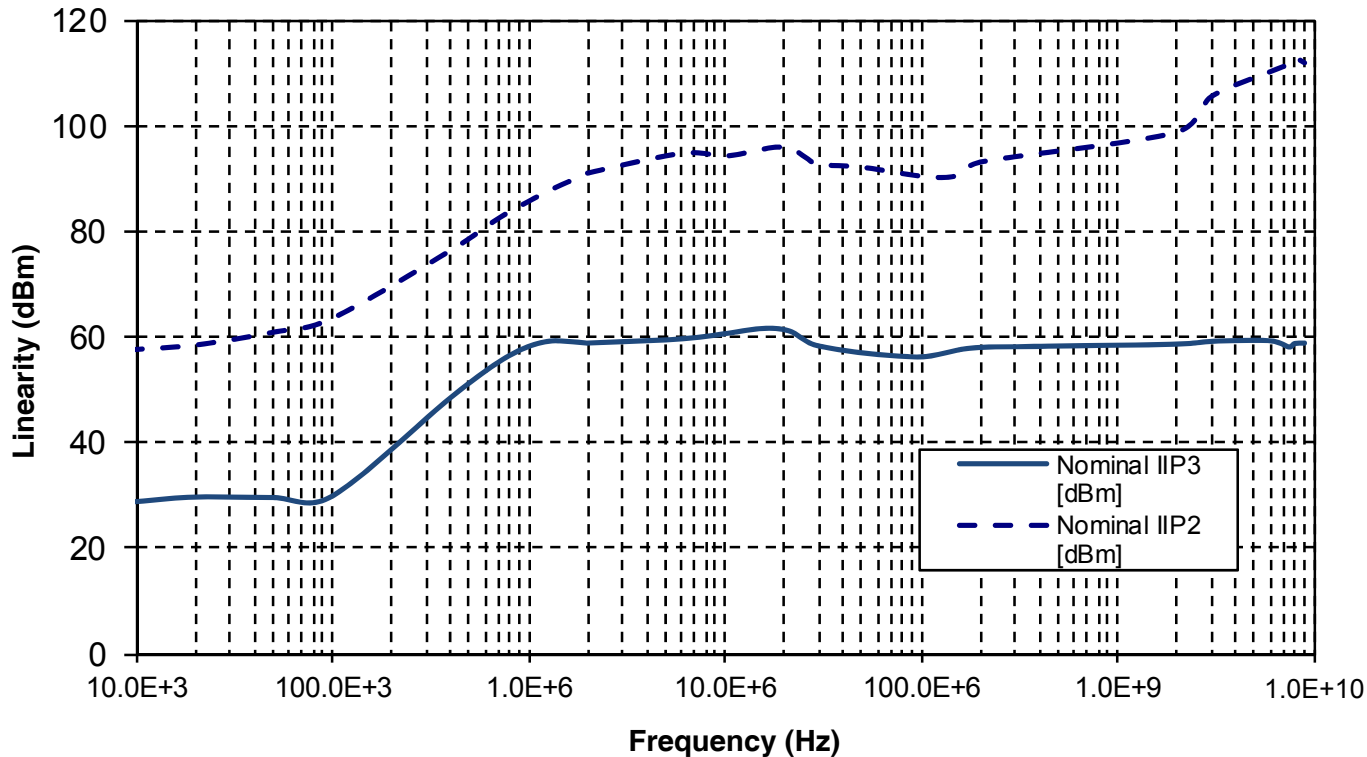




**Figure 19. RFC Port Return Loss vs. Temp**  
( $V_{DD} = 3.3V$ ,  $V_{SS} = 0$ )



**Figure 20. Linearity Performance**  
(Temp = 25°C,  $V_{DD} = 3.3V$ ,  $V_{SS} = 0$ )

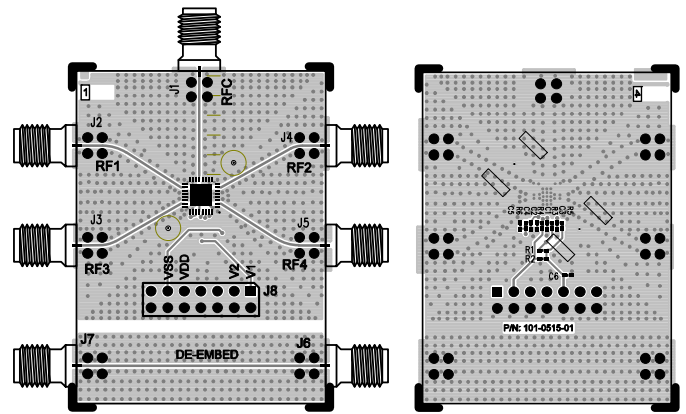


### Evaluation Kit

The SP4T switch EK Board was designed to ease customer evaluation of Peregrine’s PE42540. The RF common port is connected through a 50Ω transmission line via the top SMA connector, J1. RF1, RF2, RF3 and RF4 are connected through 50Ω transmission lines via SMA connectors J2, J4, J3 and J5, respectively. A through 50Ω transmission is available via SMA connectors J6 and J7. This transmission line can be used to estimate the loss of the PCB over the environmental conditions being evaluated.

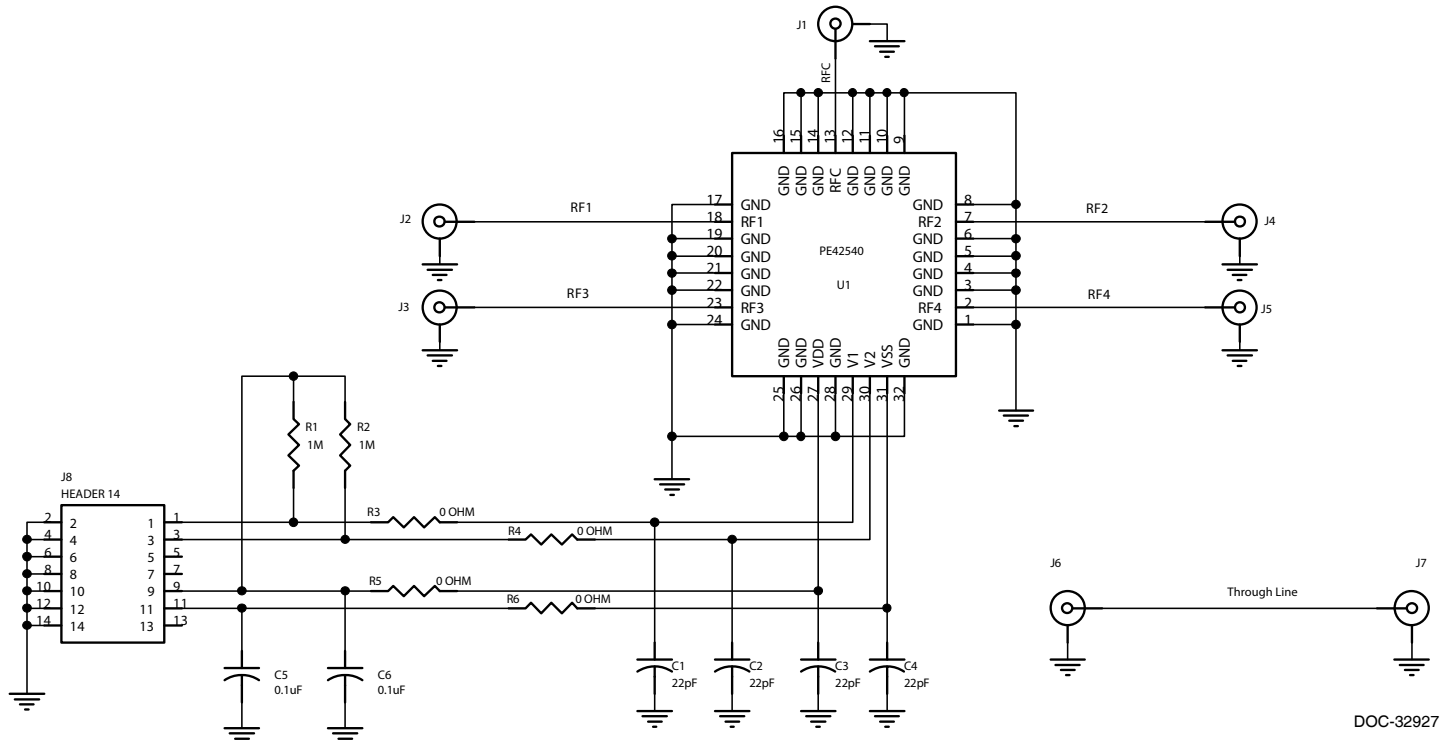
The board is constructed of a four metal layer material with a total thickness of 62 mils. The dual clad top RF layer is Rogers RO4003 material with an 8 mil RF core and  $\epsilon_r = 3.55$ . The middle layers provide ground for the transmission lines. The transmission lines were designed using a coplanar waveguide with ground plane model using a trace width of 15 mils, trace gaps of 10 mils, and metal thickness of 2.1 mils.

**Figure 21. Evaluation Board Layouts**



PRT-28605

**Figure 22. Evaluation Board Schematic**



DOC-32927

Figure 23. Package Drawing

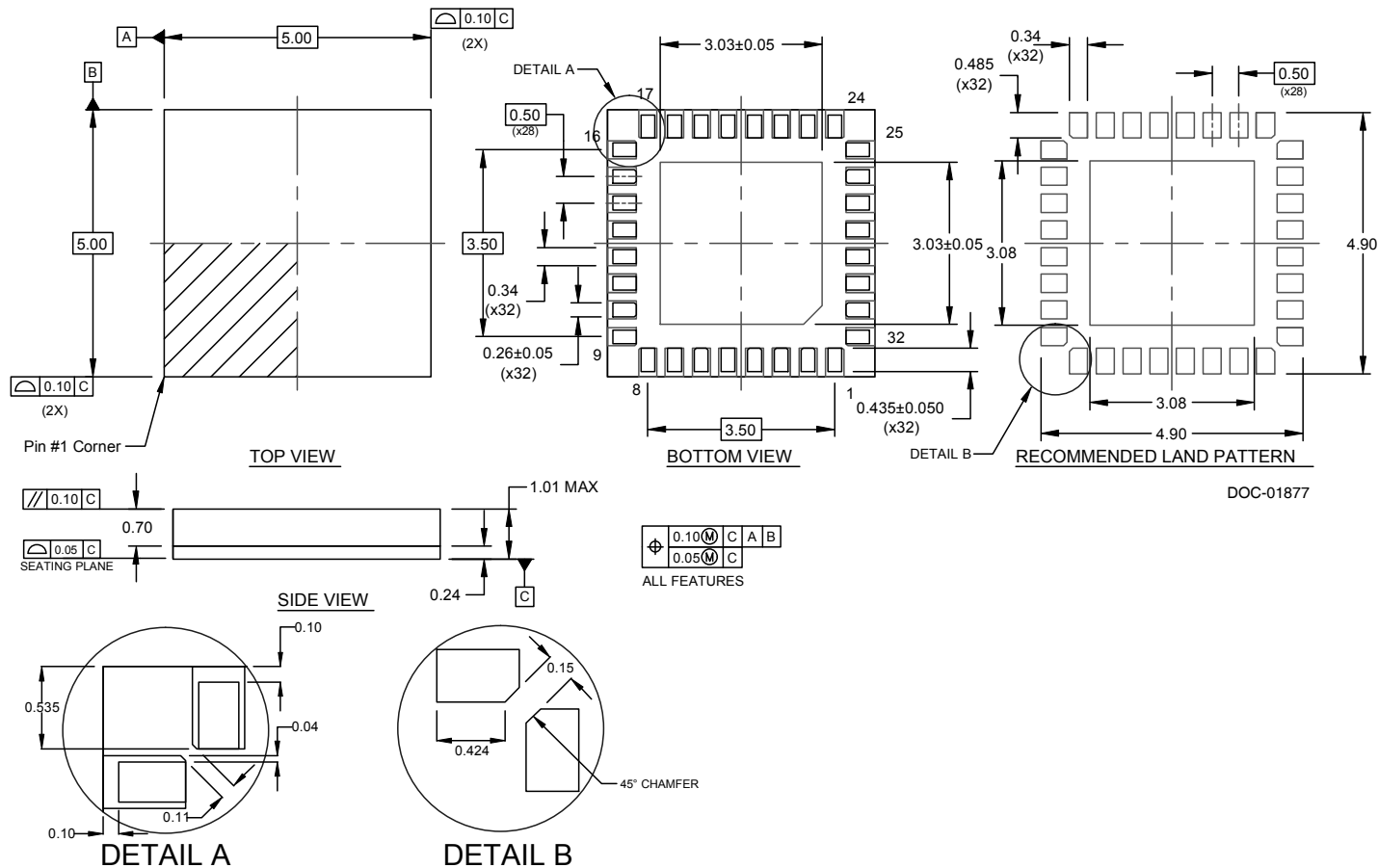
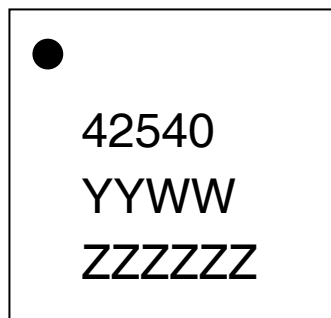


Figure 24. Marking Specifications

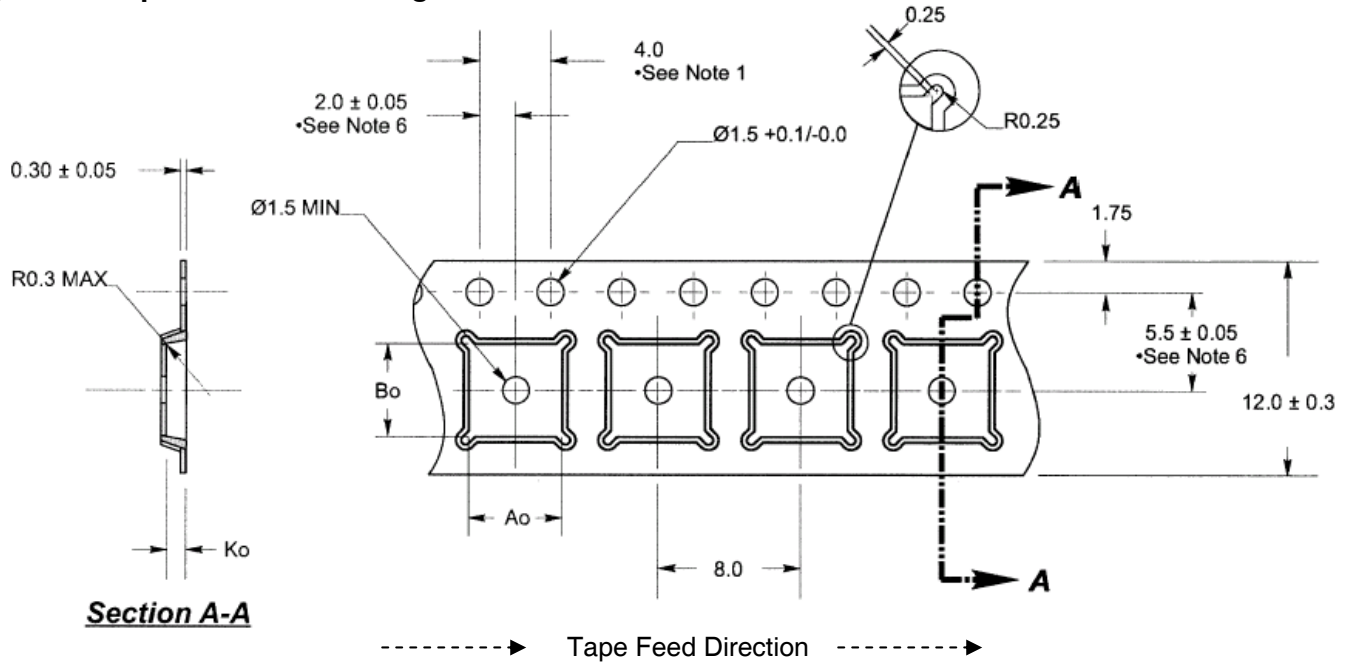


YYWW = Date Code

ZZZZZZ = Last six digits of Lot Number

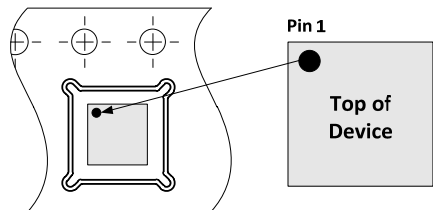
DOC-51207

**Figure 25. Tape and Reel Drawing**



- Notes:
1. 10 sprocket hole pitch cumulative tolerance  $\pm 0.02$
  2. Camber not to exceed 1 mm in 100 mm
  3. Material: PS + C
  4.  $A_o$  and  $B_o$  measured as indicated
  5.  $K_o$  measured from a plane on the inside bottom of the pocket to the top surface of the carrier
  6. Pocket position relative to sprocket hole measured as true position of pocket, not pocket hole

$A_o = 5.25 \pm 0.05$  mm  
 $B_o = 5.25 \pm 0.05$  mm  
 $K_o = 1.1 \pm 0.05$  mm



Device Orientation in Tape

**Table 7. Ordering Information**

Order Code	Description	Package	Shipping Method
PE42540LGBD-Z	PE42540 SP4T RF switch	Green 32-lead 5x5 mm LGA	3000 units / T&R
EK42540-04	PE42540 Evaluation kit	Evaluation kit	1 / Box

## Sales Contact and Information

For sales and contact information please visit [www.psemi.com](http://www.psemi.com).

**Advance Information:** The product is in a formative or design stage. The datasheet contains design target specifications for product development. Specifications and features may change in any manner without notice.  
**Preliminary Specification:** The datasheet contains preliminary data. Additional data may be added at a later date. Peregrine reserves the right to change specifications at any time without notice in order to supply the best possible product.  
**Product Specification:** The datasheet contains final data. In the event Peregrine decides to change the specifications, Peregrine will notify customers of the intended changes by issuing a CNF (Customer Notification Form).  
 The information in this datasheet is believed to be reliable. However, Peregrine assumes no liability for the use of this information. Use shall be entirely at the user's own risk.

No patent rights or licenses to any circuits described in this datasheet are implied or granted to any third party. Peregrine's products are not designed or intended for use in devices or systems intended for surgical implant, or in other applications intended to support or sustain life, or in any application in which the failure of the Peregrine product could create a situation in which personal injury or death might occur. Peregrine assumes no liability for damages, including consequential or incidental damages, arising out of the use of its products in such applications.

The Peregrine name, logo, UltraCMOS and UTSi are registered trademarks and HaRP, MultiSwitch and DuNE are trademarks of Peregrine Semiconductor Corp. Peregrine products are protected under one or more of the following U.S. Patents: <http://patents.psemi.com>.