

KEMET, SSRH7H-M, Commercial Grade, 0.0408 H

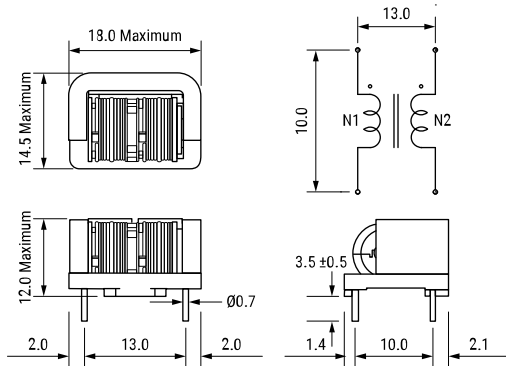

Dimensions	
L	18mm MAX
T	14.5mm MAX
H	12mm MAX
S	10mm NOM
S1	13mm NOM
LL	3.5mm +/-0.5mm
F	0.7mm NOM

Packaging Specifications	
Weight:	5.2 g
Packaging:	Bulk
Packaging Quantity:	600

General Information	
Series:	SSRH7H-M
Style:	Through-Hole Choke
Description:	Common Mode Filter, SSRH Coils, SSRH7H-M series High Impedance Type
RoHS:	Yes
Miscellaneous:	Temperature Rise Maximum: 55 K
Notes:	M05 Lot No.

Specifications	
Inductance:	40.8 mH (10 kHz)
Temperature Range:	-25/+120C
Rated Temperature:	120C
Current:	0.5 Amps
Voltage AC:	250 VAC
Withstanding Voltage:	2400 VDC