

PART NAME

POWER PLUG BOX

PART No.

PPB - 11861 (SEE NOTES)

REVISION DATE

4-3-09

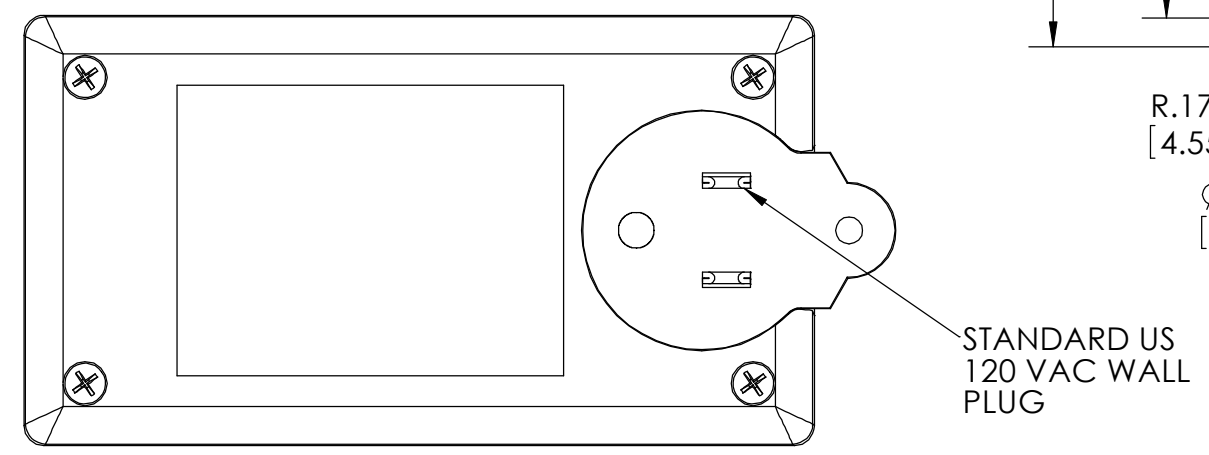
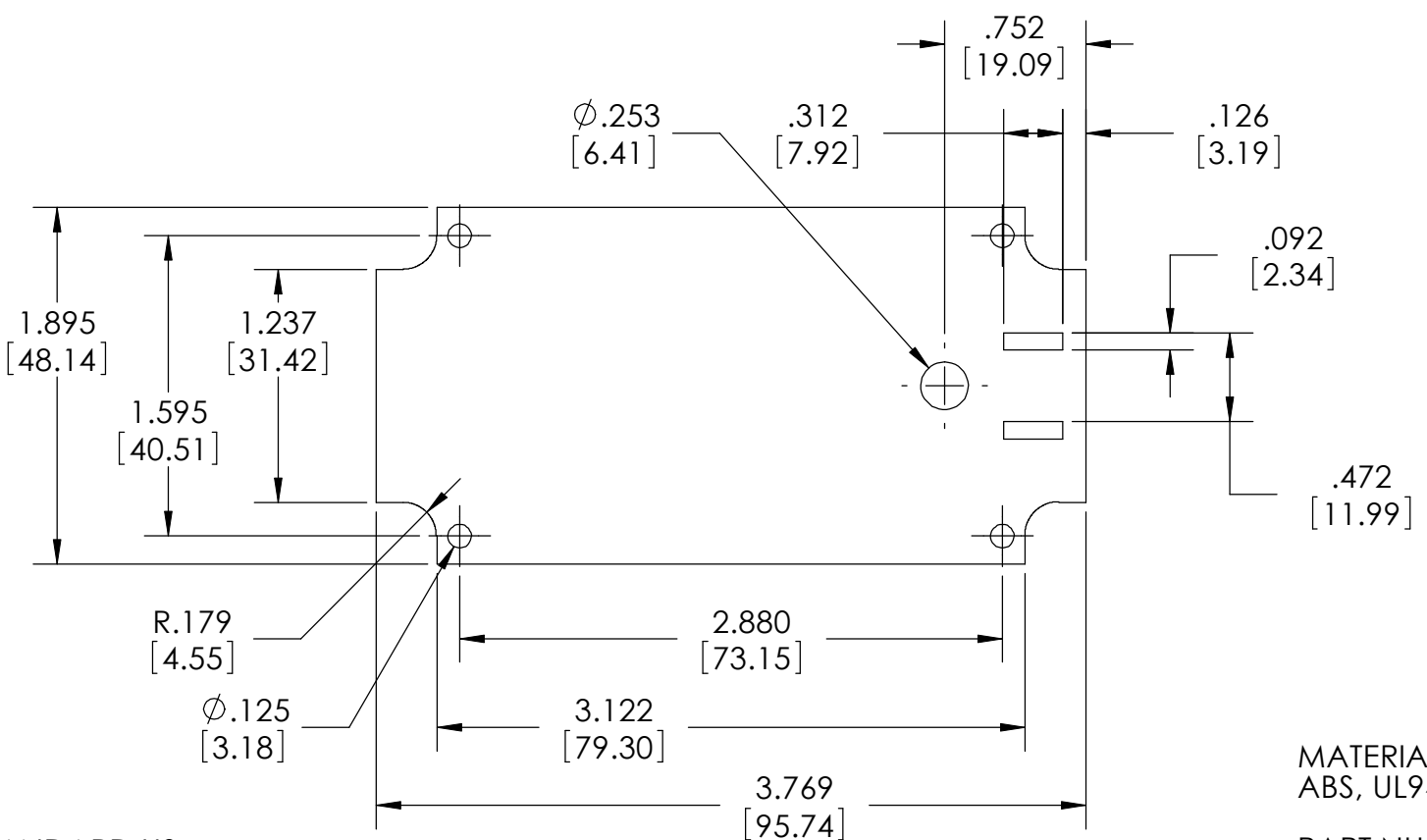
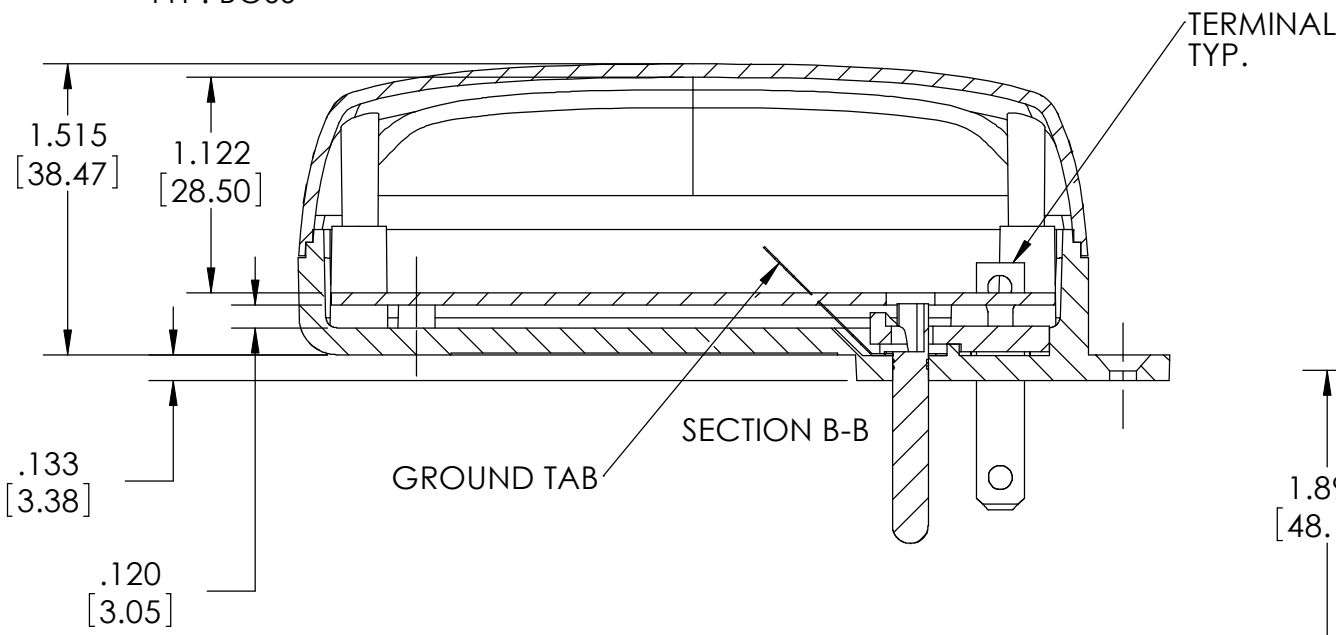
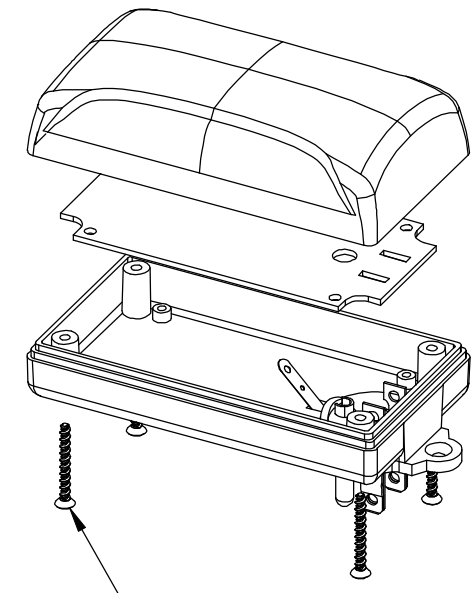
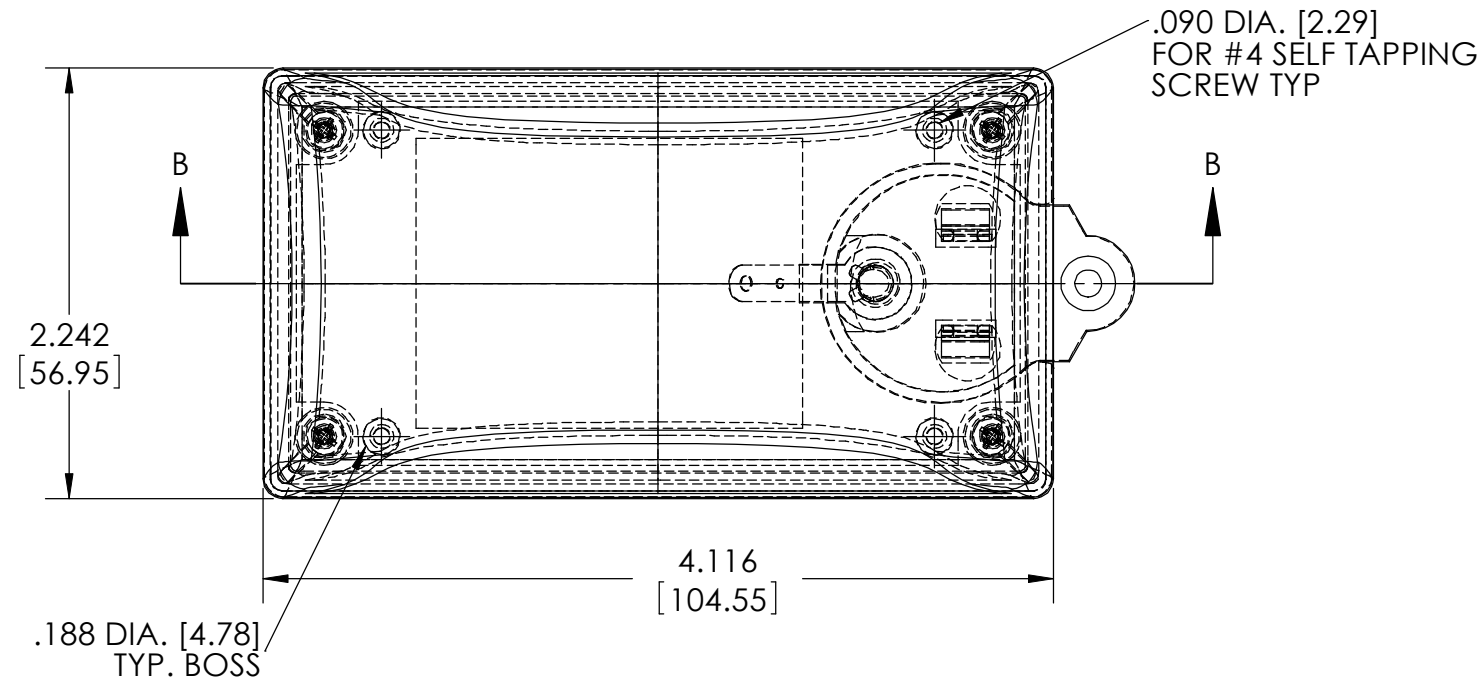

RECOMMENDED PC BOARD NOT FURNISHED

MATERIAL:
ABS, UL94VO

PART NUMBER:
PPB-11861-BK BLACK
PPB-11861-WT WHITE

MAR RESISTANT TEXTURED SURFACE