

Evaluating the **AD8273/AD8277/AD8279** Difference Amplifiers

FEATURES

- Full featured evaluation board for the **AD8273/AD8277/AD8279**
- On-board voltage regulator
- Low cost and easy to use header for control signals
- All analog design, no software needed
- Footprints provided for alternate configurations

EVALUATION KIT CONTENTS

- AD8273-EVALZ/AD8277-EVALZ/AD8279-EVALZ** evaluation board
- AD8273-EVALZ/AD8277-EVALZ/AD8279-EVALZ** user guide (UG-744)

ADDITIONAL EQUIPMENT NEEDED

- A signal generator
- A single- or dual-output power supply
- An oscilloscope with at least 20 MHz of bandwidth
- BNC cables for signal interconnects
- Test clips for power

ONLINE RESOURCES

- AD8273** data sheet
- AD8277** data sheet
- AD8279** data sheet

GENERAL DESCRIPTION

This user guide describes the evaluation board for the **AD8273/AD8277/AD8279**. The design of this board emphasizes simplicity and ease of use. The **AD8273/AD8277/AD8279** board comes with a ready assortment of connection options (BNC and RCA connectors), and many configurations are set by jumpers.

The **AD8273**, **AD8277**, and **AD8279** data sheets cover the details of operation of the devices. Using these data sheets for reference helps designers in their end application. The data sheets are helpful for understanding the operation of the **AD8273/AD8277/AD8279**, especially during the initial configuration and when powering the board up for the first time.

AD8273/AD8277/AD8279 EVALUATION BOARD PHOTOGRAPH

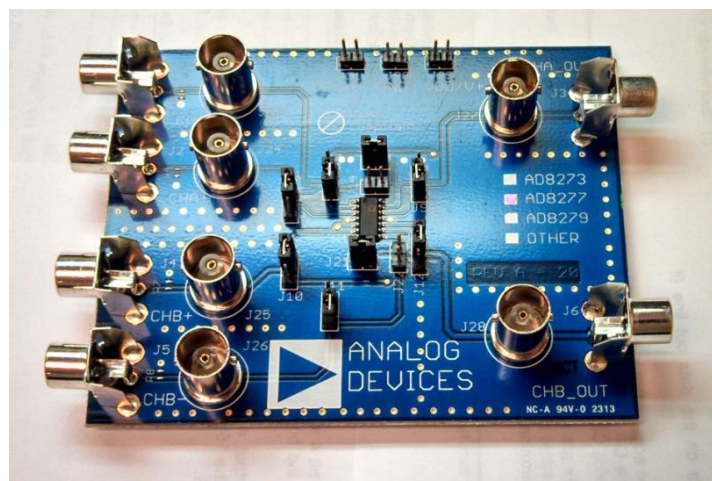

Figure 1. **AD8273/AD8277/AD8279** Evaluation Board

TABLE OF CONTENTS

Features	1	Initial Configuration	3
Evaluation Kit Contents.....	1	Power Up	4
Additional Equipment Needed.....	1	Link Configuration Options	5
Online Resources	1	Jumper Configurations.....	5
General Description	1	Factory Default Condition	5
AD8273/AD8277/AD8279 Evaluation Board Photograph.....	1	Configurations for Channel 1.....	5
Revision History	2	Configurations for Channel 2.....	5
Quick Start.....	3	Evaluation Board Schematic	6
Overview.....	3	Ordering Information.....	7
Required Equipment	3	Bill of Materials.....	7

REVISION HISTORY

8/15—Rev. 0 to Rev. A

Changes to Figure 8.....	5
Changes to Table 1.....	7

8/14—Revision 0: Initial Version

QUICK START

OVERVIEW

This section outlines the basic configuration of the [AD8273/AD8277/AD8279](#) evaluation board to test for basic functionality. It outlines the best option for the initial user experience to start up and running quickly. The expected time to be up and running is about ten minutes.

REQUIRED EQUIPMENT

Besides the [AD8273/AD8277/AD8279](#) evaluation board, a minimum of eight other items are required (see Figure 2).

- A signal source such as an arbitrary waveform generator
- A single or dual output power supply
- An oscilloscope
- Two cables, typically BNC to BNC, to connect the test equipment to the [AD8273/AD8277/AD8279](#) evaluation board
- Three clip leads to connect the power supply to the [AD8273/AD8277/AD8279](#) evaluation board

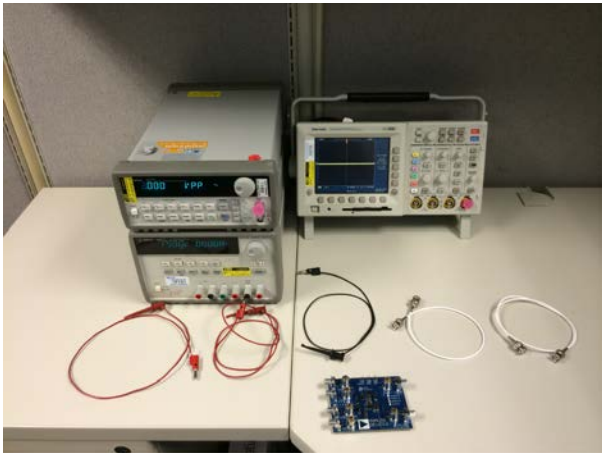

Figure 2. An Example of the Minimal Requirements for Quick Start Operation

INITIAL CONFIGURATION

To begin the initial board configuration, use the following steps:

1. With the power supply off, connect the power supply leads to the header, located at the top of the board (see Figure 3).

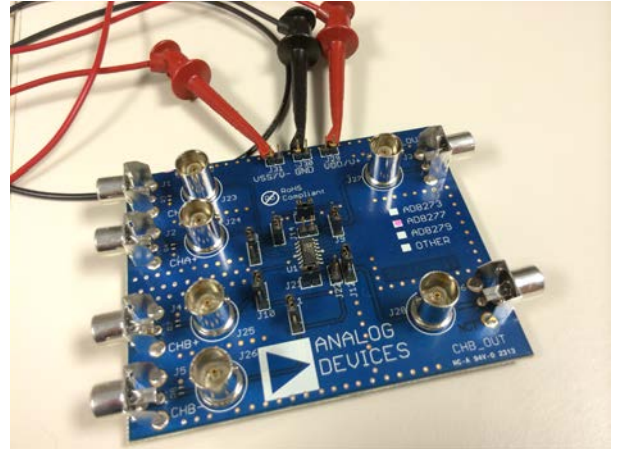

Figure 3. The [AD8273/AD8277/AD8279](#) Evaluation Board with the Basic Power Connections

2. For a single input signal source, the [AD8273/AD8277/AD8279](#) evaluation board performs best in the noninverting mode of operation. No jumper changes are required for this mode. Connect the signal source to the BNC connector designated J24, as shown in Figure 4.

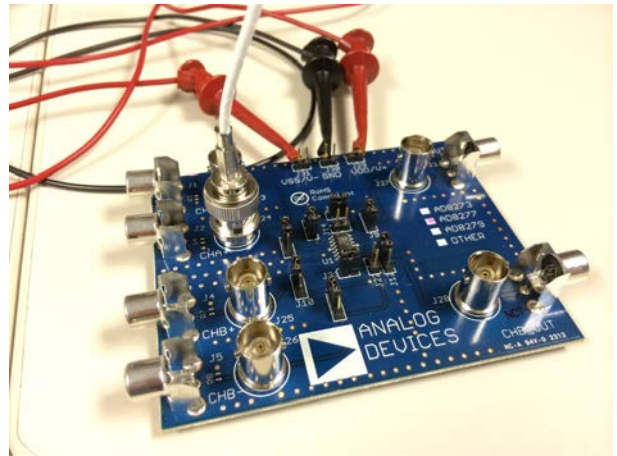

Figure 4. The [AD8273/AD8277/AD8279](#) Evaluation Board with the Source Signal Connected

3. Lastly, connect a BNC to BNC cable to the oscilloscope and Connector J27. This step completes the connections for using Channel 1 of the [AD8273/AD8277/AD8279](#) (see Figure 5).

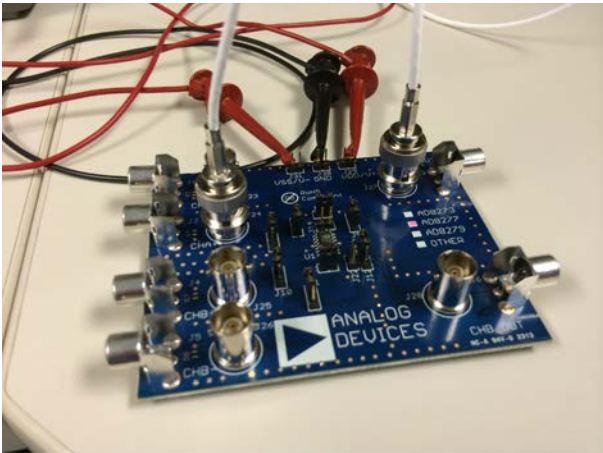

Figure 5. Completed Connections for Quick Start Usage

POWER UP

With the initial configuration complete, use the following steps to power up the [AD8273/AD8277/AD8279](#) evaluation board:

1. Set the power supply to either ± 5.0 V or +5.0 V.
2. Turn on the supply. The [AD8273/AD8277/AD8279](#) are very low in quiescent current; as a result, some power supplies may not report any current load.
3. Configure the signal source to output a 1 kHz sine wave at 2 V p-p. (Note that if the signal source is relative to a 50 Ω impedance, set the amplitude to 1 V p-p.)

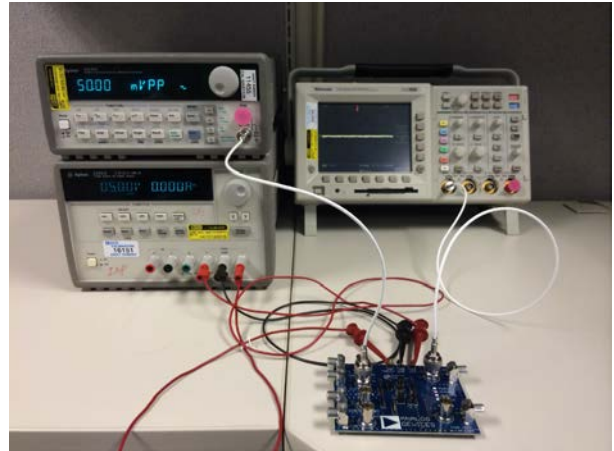

Figure 6. The Completed Setup

4. Enable the signal source. For the [AD8277](#), a 2 V p-p sine wave appears on the output of the oscilloscope. For the [AD8273](#) and [AD8279](#), a 1 V p-p sine wave appears on the output of the oscilloscope.

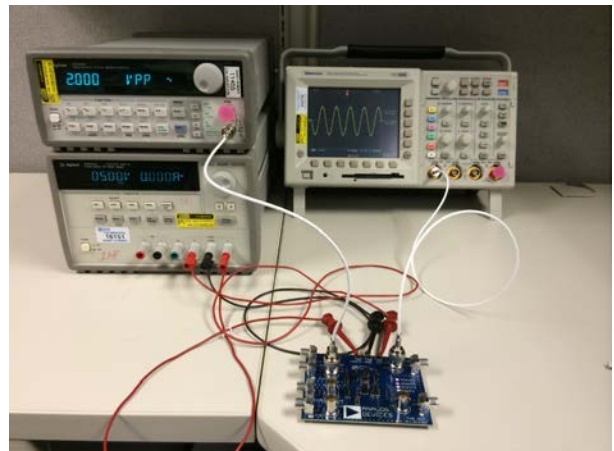

Figure 7. Final Result with 2 V p-p Signal Appearing on the Oscilloscope Using the [AD8277-EVALZ](#)

LINK CONFIGURATION OPTIONS

JUMPER CONFIGURATIONS

The AD8273/AD8277/AD8279 evaluation board offers the user many permutations of device configuration by selecting the appropriate jumpers. Each channel has an independent set of jumpers associated with its configuration and setup.

FACTORY DEFAULT CONDITION

For the AD8273 and AD8279, the factory default configuration is a difference amplifier with a gain of 0.5. For the AD8277, the factory default configuration is a difference amplifier with a gain of 1.

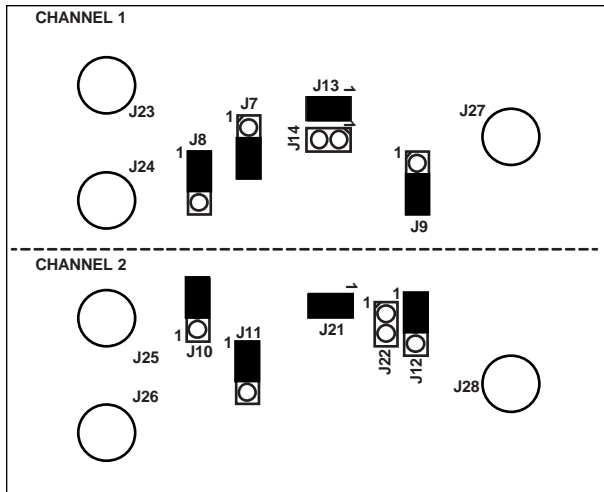

Figure 8. Factory Default Jumper Configuration

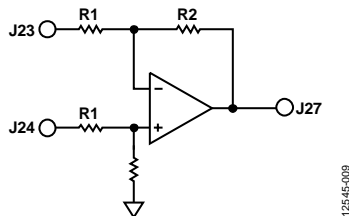

Figure 9. Factory Configuration for Channel 1 (Difference Amplifier)

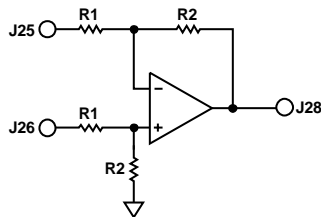

Figure 10. Factory Configuration for Channel 2 (Difference Amplifier)

CONFIGURATIONS FOR CHANNEL 1

Gain of 2, Difference Amplifier for AD8273 or AD8279

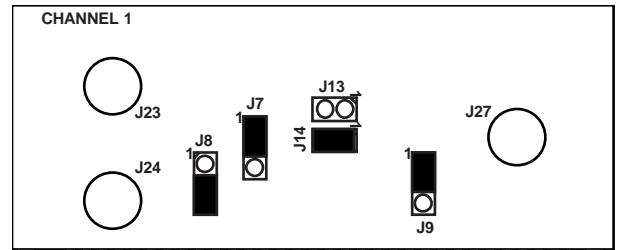

Figure 11. Schematic for Gain of 2, Difference Amplifier Setting (Note That for the AD8277, the Gain is Still 1)

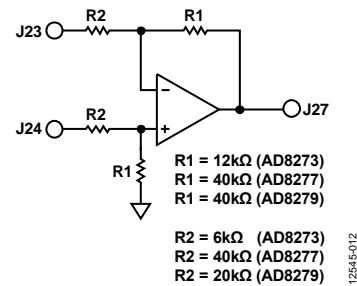

Figure 12. Jumper Configuration for Gain of 2, Difference Amplifier Setting (Note That for the AD8277, the Gain is Still 1)

CONFIGURATIONS FOR CHANNEL 2

Gain of 2, Difference Amplifier for AD8273 and AD8279

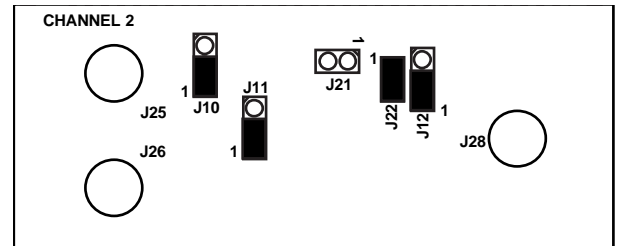

Figure 13. Schematic for Gain of 2, Difference Amplifier Setting (Note That for the AD8277, the Gain is Still 1)

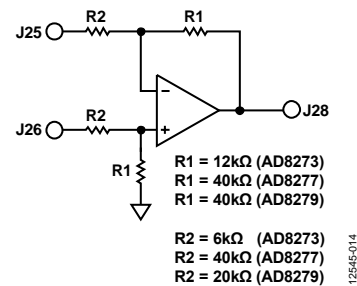

Figure 14. Jumper Configuration for Gain of 2, Difference Amplifier Setting (Note That for the AD8277, the Gain is Still 1)

EVALUATION BOARD SCHEMATIC

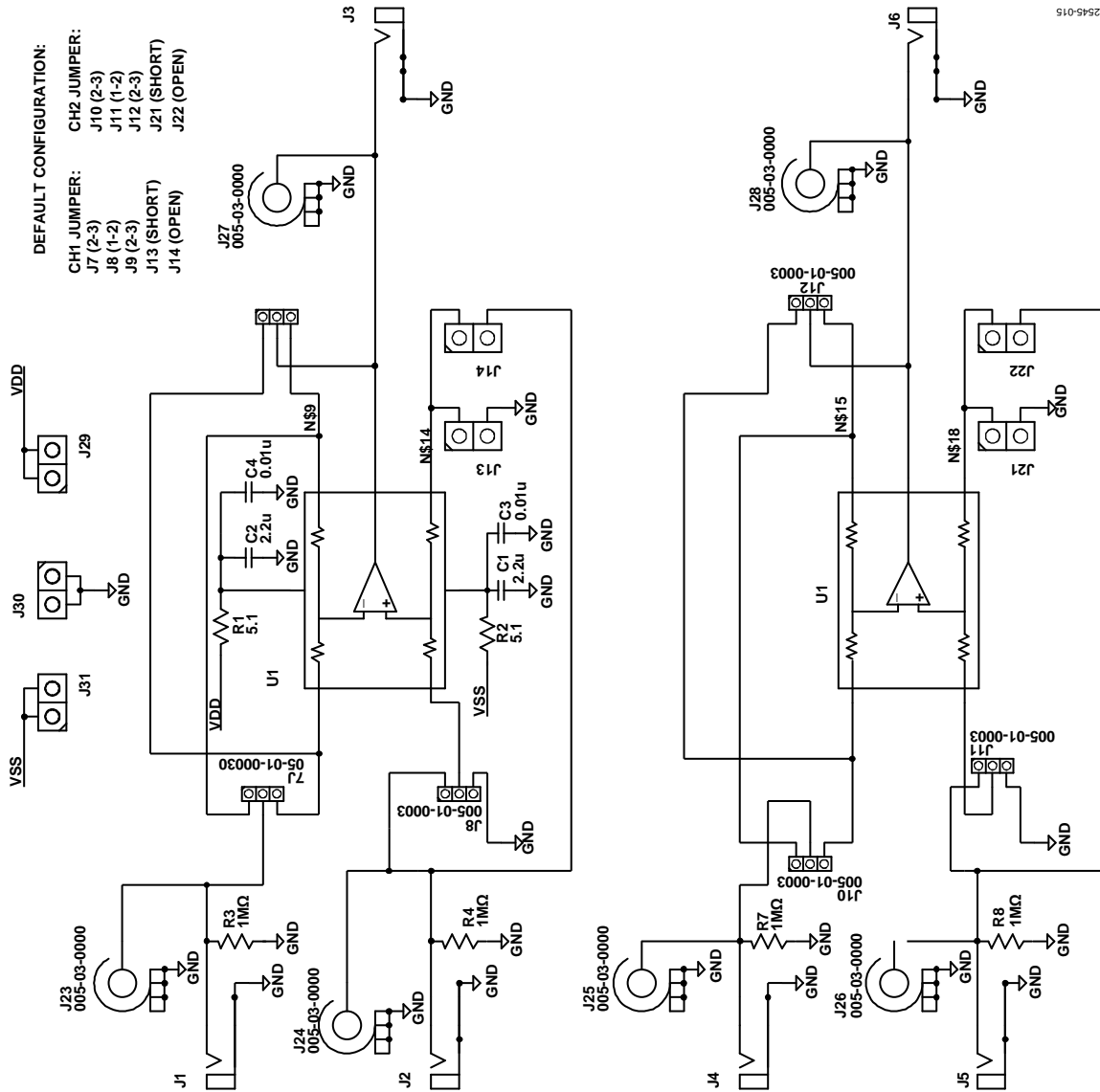

Figure 15. AD8273/AD8277/AD8279 Evaluation Board Schematic

ORDERING INFORMATION

BILL OF MATERIALS

Table 1.

Quantity	Value	Designator	Manufacturer Part Number	Manufacturer
2	2.2 μ F	C1, C2	UMK316BJ225KD-T	Taiyo
2	0.01 μ F	C3, C4	C1608X7R1H103K080AA	TDK
6	RCA/RA	J1, J2, J3, J4, J5, J6	RCJ-011	CUI Inc
6	SIP-3	J7, J8, J9, J10, J11, J12	68000-103HLF	FCI
6	BNC	J23, J24, J25, J26, J27, J28	5-1634503-1	TE Connectivity
7	Not applicable	J13, J14, J21, J22, J29, J30, J31	5-146285-2	TE Connectivity
2	5.1 Ω	R1, R2	RMCF1206JT5R10	Stackpole
1	AD8273ARZ , AD8277ARZ , or AD8279ARZ	U1	AD8273ARZ , AD8277ARZ , AD8279ARZ	Analog Devices, Inc.



ESD Caution

ESD (electrostatic discharge) sensitive device. Charged devices and circuit boards can discharge without detection. Although this product features patented or proprietary protection circuitry, damage may occur on devices subjected to high energy ESD. Therefore, proper ESD precautions should be taken to avoid performance degradation or loss of functionality.

Legal Terms and Conditions

By using the evaluation board discussed herein (together with any tools, components documentation or support materials, the "Evaluation Board"), you are agreeing to be bound by the terms and conditions set forth below ("Agreement") unless you have purchased the Evaluation Board, in which case the Analog Devices Standard Terms and Conditions of Sale shall govern. Do not use the Evaluation Board until you have read and agreed to the Agreement. Your use of the Evaluation Board shall signify your acceptance of the Agreement. This Agreement is made by and between you ("Customer") and Analog Devices, Inc. ("ADI"), with its principal place of business at One Technology Way, Norwood, MA 02062, USA. Subject to the terms and conditions of the Agreement, ADI hereby grants to Customer a free, limited, personal, temporary, non-exclusive, non-sublicensable, non-transferable license to use the Evaluation Board FOR EVALUATION PURPOSES ONLY. Customer understands and agrees that the Evaluation Board is provided for the sole and exclusive purpose referenced above, and agrees not to use the Evaluation Board for any other purpose. Furthermore, the license granted is expressly made subject to the following additional limitations: Customer shall not (i) rent, lease, display, sell, transfer, assign, sublicense, or distribute the Evaluation Board; and (ii) permit any Third Party to access the Evaluation Board. As used herein, the term "Third Party" includes any entity other than ADI, Customer, their employees, affiliates and in-house consultants. The Evaluation Board is NOT sold to Customer; all rights not expressly granted herein, including ownership of the Evaluation Board, are reserved by ADI. CONFIDENTIALITY. This Agreement and the Evaluation Board shall all be considered the confidential and proprietary information of ADI. Customer may not disclose or transfer any portion of the Evaluation Board to any other party for any reason. Upon discontinuation of use of the Evaluation Board or termination of this Agreement, Customer agrees to promptly return the Evaluation Board to ADI. ADDITIONAL RESTRICTIONS. Customer may not disassemble, decompile or reverse engineer chips on the Evaluation Board. Customer shall inform ADI of any occurred damages or any modifications or alterations it makes to the Evaluation Board, including but not limited to soldering or any other activity that affects the material content of the Evaluation Board. Modifications to the Evaluation Board must comply with applicable law, including but not limited to the RoHS Directive. TERMINATION. ADI may terminate this Agreement at any time upon giving written notice to Customer. Customer agrees to return to ADI the Evaluation Board at that time. LIMITATION OF LIABILITY. THE EVALUATION BOARD PROVIDED HEREUNDER IS PROVIDED "AS IS" AND ADI MAKES NO WARRANTIES OR REPRESENTATIONS OF ANY KIND WITH RESPECT TO IT. ADI SPECIFICALLY DISCLAIMS ANY REPRESENTATIONS, ENDORSEMENTS, GUARANTEES, OR WARRANTIES, EXPRESS OR IMPLIED, RELATED TO THE EVALUATION BOARD INCLUDING, BUT NOT LIMITED TO, THE IMPLIED WARRANTY OF MERCHANTABILITY, TITLE, FITNESS FOR A PARTICULAR PURPOSE OR NON-INFRINGEMENT OF INTELLECTUAL PROPERTY RIGHTS. IN NO EVENT WILL ADI AND ITS LICENSORS BE LIABLE FOR ANY INCIDENTAL, SPECIAL, INDIRECT, OR CONSEQUENTIAL DAMAGES RESULTING FROM CUSTOMER'S POSSESSION OR USE OF THE EVALUATION BOARD, INCLUDING BUT NOT LIMITED TO LOST PROFITS, DELAY COSTS, LABOR COSTS OR LOSS OF GOODWILL. ADI'S TOTAL LIABILITY FROM ANY AND ALL CAUSES SHALL BE LIMITED TO THE AMOUNT OF ONE HUNDRED US DOLLARS (\$100.00). EXPORT. Customer agrees that it will not directly or indirectly export the Evaluation Board to another country, and that it will comply with all applicable United States federal laws and regulations relating to exports. GOVERNING LAW. This Agreement shall be governed by and construed in accordance with the substantive laws of the Commonwealth of Massachusetts (excluding conflict of law rules). Any legal action regarding this Agreement will be heard in the state or federal courts having jurisdiction in Suffolk County, Massachusetts, and Customer hereby submits to the personal jurisdiction and venue of such courts. The United Nations Convention on Contracts for the International Sale of Goods shall not apply to this Agreement and is expressly disclaimed.