

Assembly Instructions for - 37174

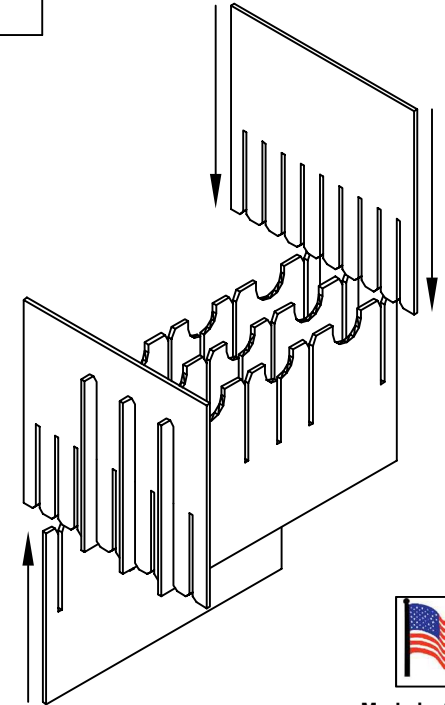
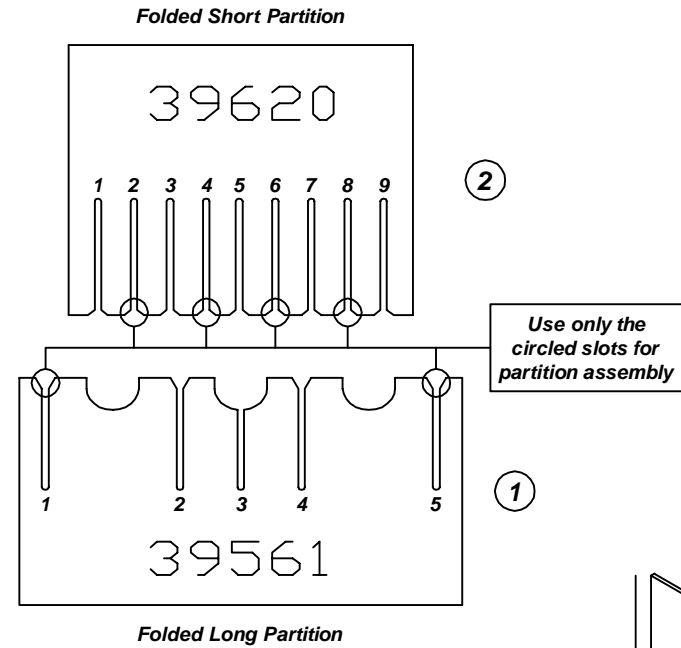
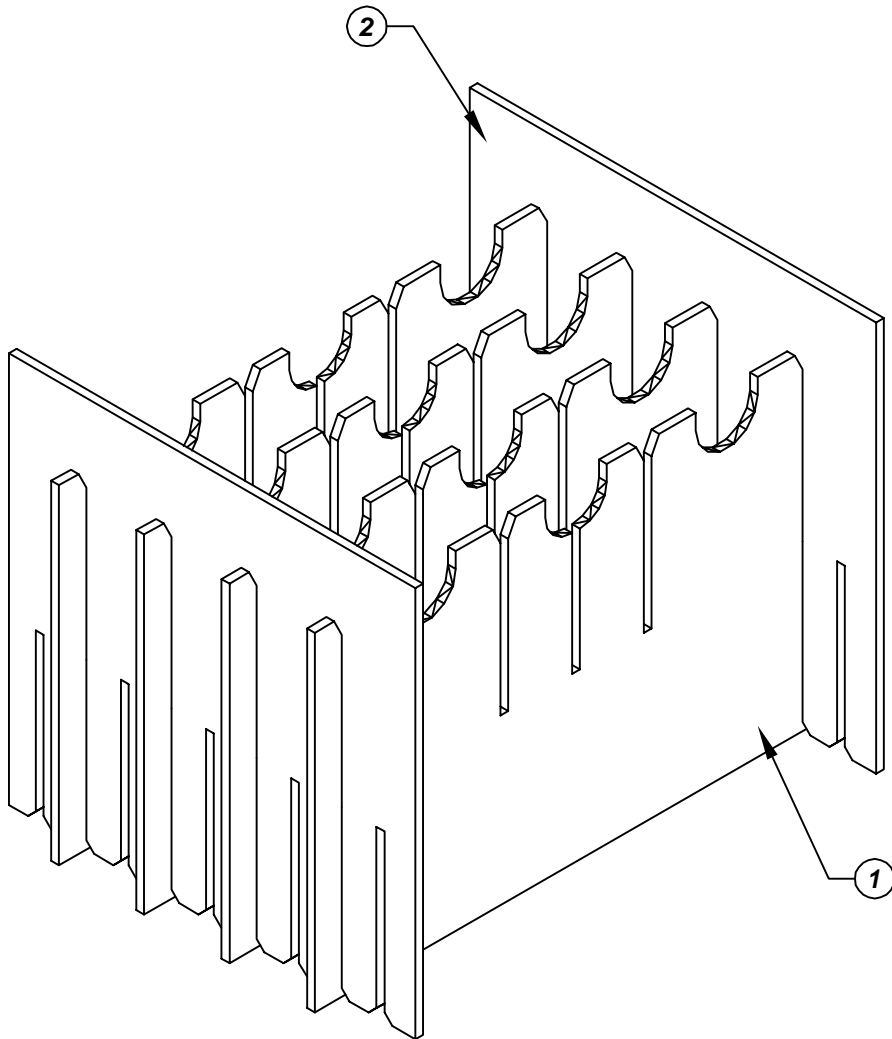

Made in America

F/N ①	Part # 39561	Dimensions: 21-1/2" x 16-7/8"	Description: 439/403/434-LP Long Partition	Qty: 4
F/N ②	Part # 39620	Dimensions: 25-1/2" x 13-1/8"	Description: 403-SP Short Partition	Qty: 2

37174 - 5 Cell Inplant Handler
Cell Size - 12-5/8" x 14-5/8" x 2-3/8"

Notes:
 For use with the following storage container & lid:
 37503 - Storage Container
 37551 - Lid

PROTEKTIVE PAK
 13520 MONTE VISTA AVENUE, CHINO, CA 91710
 PHONE (909) 627-2578, FAX (909) 363-7331
 ProtektivePak.com



DRAWING NUMBER
IPH-37174

DATE
 Dec.
 2007