

QT-Brightek PLCC Series

PLCC2 LED

Part No.: QBLP670 Series

Product: QBLP670_series	Date: March 09, 2015	Page 1 of 12
	Version# 3.3	

Table of Contents:

Introduction	3
Electrical / Optical Characteristic (Ta=25 °C)	4
Absolute Maximum Rating	4
Characteristic Curves.....	7
Solder Profile & Footprint.....	9
Packing	10
Labeling	11
Ordering Information	11
Revision History	12
Disclaimer	12

Introduction

Feature:

- Package in tape and reel
- Ultra bright reflector type PLCC2 LED
- InGaN technology for IB/IG/UV
- AlInGaP technology for R/AG/Y/O/S
- 120 degree viewing angle

Description:

These ultra bright reflector type PLCC2 LEDs have a height profile of 1.90mm. Combination of high brightness output and robust package, these LEDs are ideal for architecture lighting, status indication, and industrial equipment lighting applications.

Application:

- Status indication
- Industrial equipment backlighting
- Architecture lighting

Certification & Compliance:

- TS16949
- ISO9001
- RoHS Compliant



Dimension:

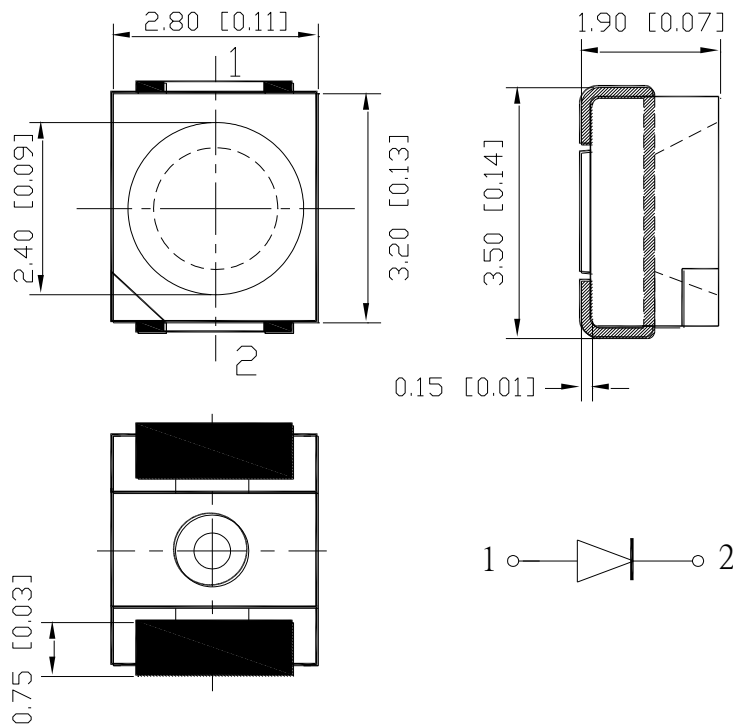

Units: mm / tolerance = +/-0.2mm

Electrical / Optical Characteristic (Ta=25 °C)

Product	Color	I _F (mA)	V _F (V)		λ _D (nm) / λ _P (nm) for UV			I _V (mcd)	
			Typ.	Max.	Min.	Typ.	Max.	Min.	Typ.
QBLP670-IB	Blue	20	3.1	3.7	465	470	475	100	210
QBLP670-IG	True Green	20	3.1	3.7	520	525	530	500	900
QBLP670-UV	UV	20	3.2	3.7	400	405	410	80	125
QBLP670-R	Red	20	2.0	2.5	615	620	630	125	230
QBLP670-AG	Yellow Green	20	2.0	2.5	565	570	576	40	80
QBLP670-Y	Yellow	20	2.0	2.5	585	590	595	125	210
QBLP670-O	Orange	20	2.0	2.5	600	605	612	160	240
QBLP670-S	Deep Red	20	2.0	2.5	630	640	650	50	80

Absolute Maximum Rating

Material	P _d (mW)	I _F (mA)	I _{FP} (mA)*	V _R (V)	T _{OP} (°C)	T _{ST} (°C)	T _{SO L} (°C)**
InGaN (IB/IG/UV)	120	30	100	5	-40 ~ +85	-40 ~ +100	260
AllnGaP (R/AG/Y/O/S)	75	30	125	5	-40 ~ +85	-40 ~ +100	260

*Duty 1/8 @ 1KHz

**IR Reflow for no more than 10 sec @ 260 °C

Forward Voltage V_F for AllnGaP @ I_F=20mA

Bin	Min.	Max.	Unit
□	1.7	2.5	V

Forward Voltage V_F for InGaN @ I_F=20mA

Bin	Min.	Max.	Unit
f	2.8	3.1	V
g	3.1	3.4	
h	3.4	3.7	

Dominant Wavelength λ_D for Blue @ $I_F=20mA$

Bin	Min.	Max.	Unit
G	465	467.5	nm
H	467.5	470	
I	470	472.5	
J	472.5	475	

Dominant Wavelength λ_D for Green @ $I_F=20mA$

Bin	Min.	Max.	Unit
U	520	522.5	nm
V	522.5	525	
W	525	527.5	
X	527.5	530	

Dominant Wavelength λ_D for Red @ $I_F=20mA$

Bin	Min.	Max.	Unit
s	615	620	nm
t	620	625	
u	625	630	

Dominant Wavelength λ_D for Yellow Green @ $I_F=20mA$

Bin	Min.	Max.	Unit
h	565	568	nm
i	568	572	
j	572	576	

Dominant Wavelength λ_D for Yellow @ $I_F=20mA$

Bin	Min.	Max.	Unit
m	585	590	nm
n	590	595	

Dominant Wavelength λ_D for Orange @ $I_F=20mA$

Bin	Min.	Max.	Unit
p	600	605	nm
q	605	610	

Dominant Wavelength λ_D for Deep Red @ $I_F=20mA$

Bin	Min.	Max.	Unit
v	630	635	nm
w	635	650	

Peak Wavelength λ_p for UV @ $I_F=20mA$

Bin	Min.	Max.	Unit
G	400	405	nm
H	405	410	

Luminous Intensity I_v @ $I_F=20mA$

Bin	Min.	Max.	Unit
F	40	50	mcd
G	50	63	
H	63	80	
I	80	100	
J	100	125	
K	125	160	
L	160	200	
M	200	250	
N	250	320	
O	320	400	
P	400	500	
Q	500	630	
R	630	800	
S	800	1000	
T	1000	1250	
U	1250	1600	

Characteristic Curves

AllnGaP (R/AG/Y/O/S)

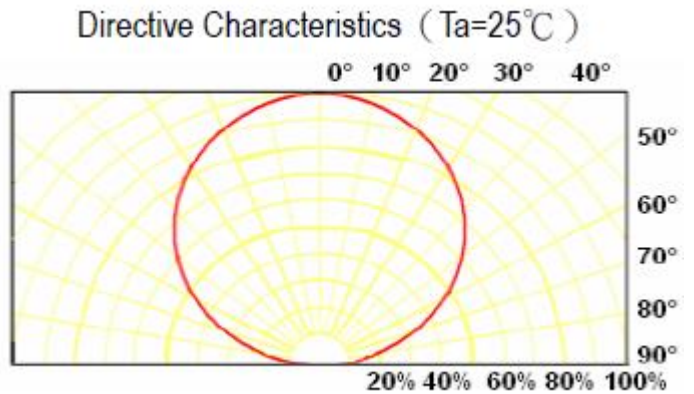
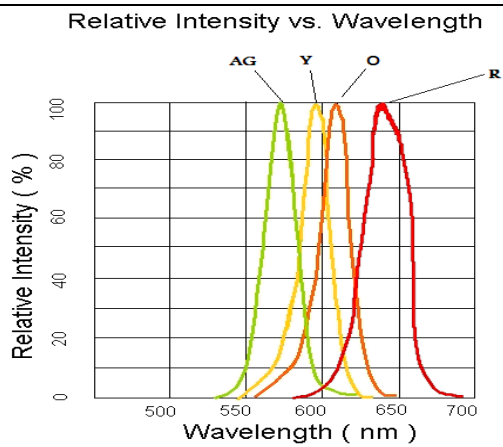
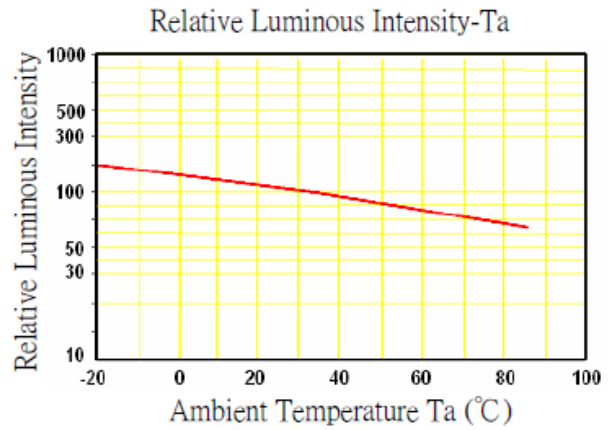
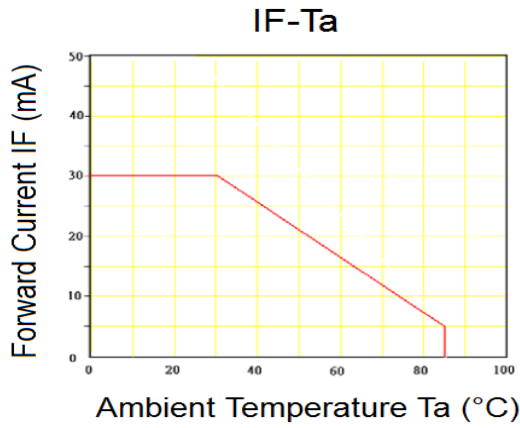
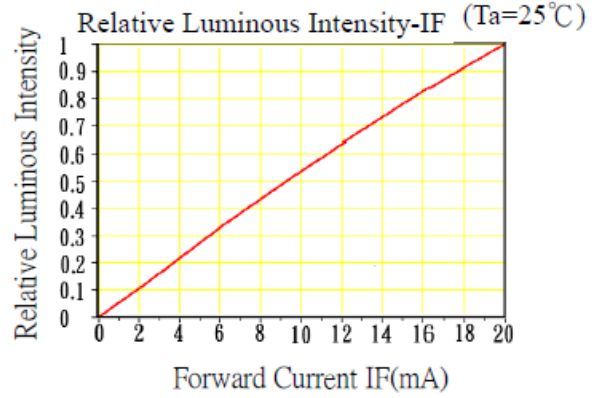
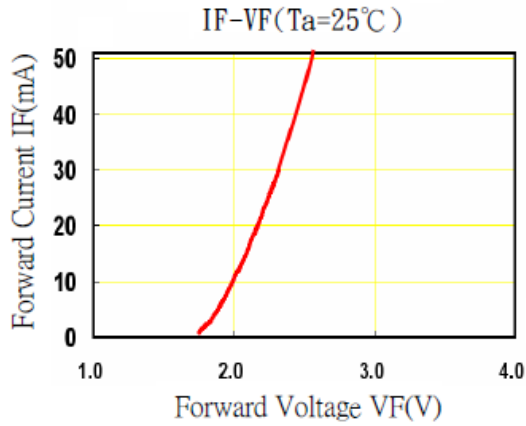

InGaN (IB/IG/UV)

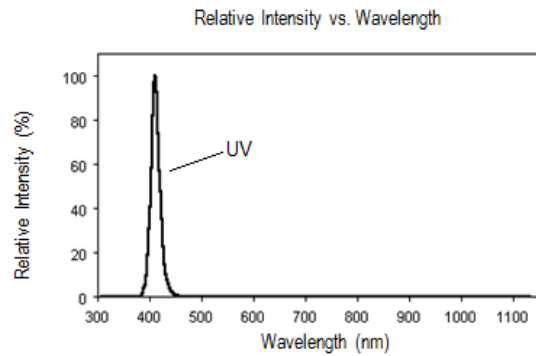
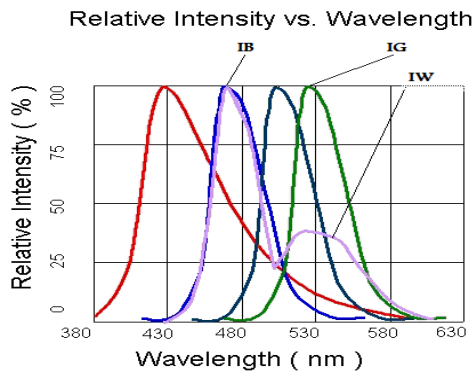
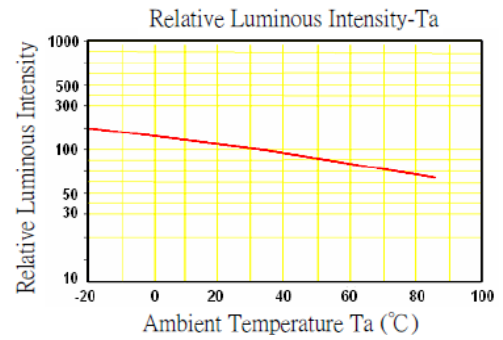
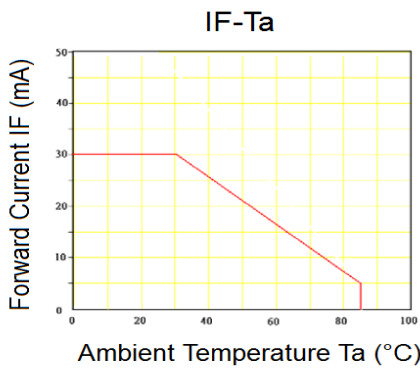
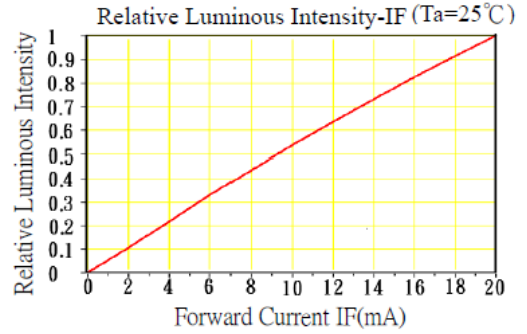
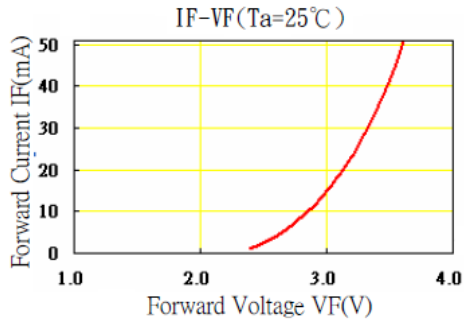

Directive Characteristics (Ta=25°C)

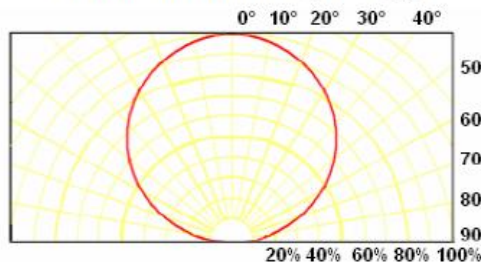

Solder Profile & Footprint

- Recommended tin solder specifications: melting temperature in the range of 178~192 °C
- The recommended lead free reflow soldering profile is as follows (temperatures indicated are as measured on the surface of the LED resin):

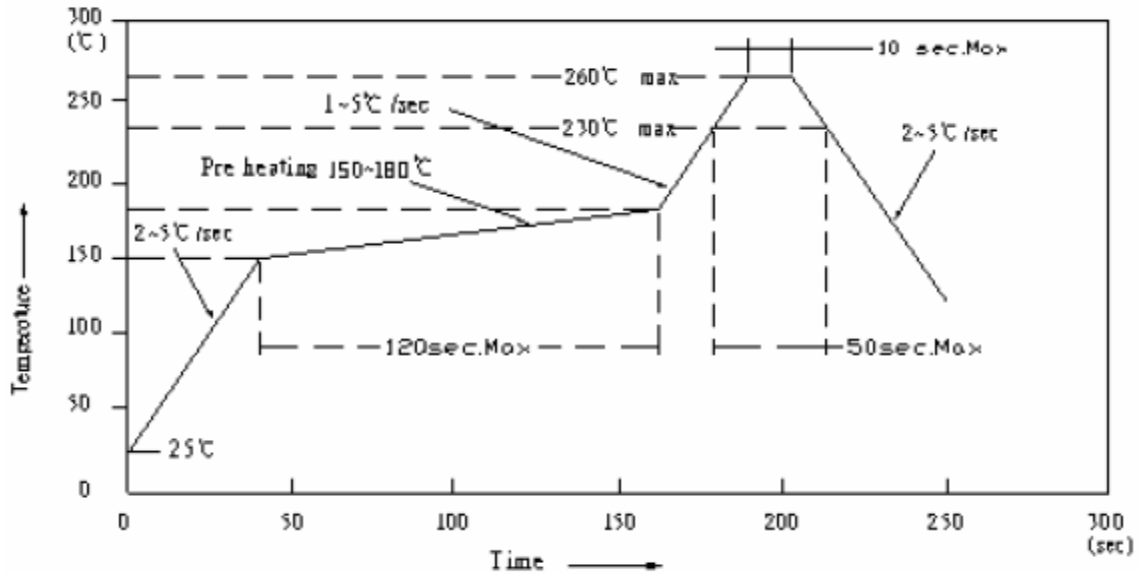

RECOMMEND PADLAYOUT

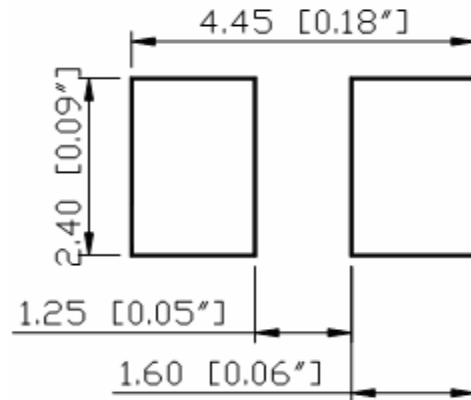

Units: mm

tolerance: +/- 0.1mm

Packing

Reel Dimension:

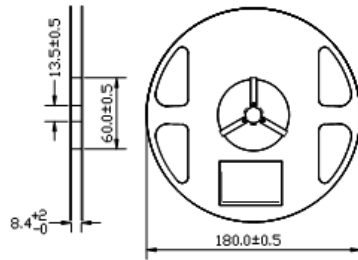

Unit: mm

Tape Dimension:

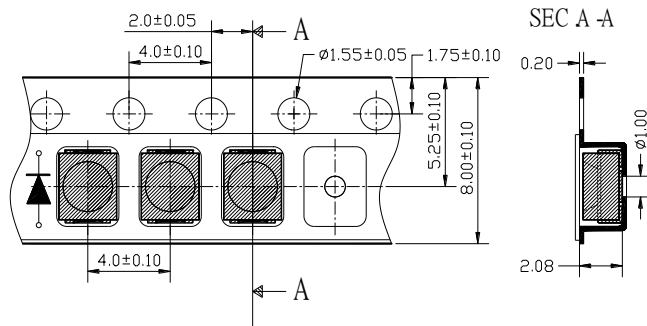

Unit: mm

Arrangement of Tape:

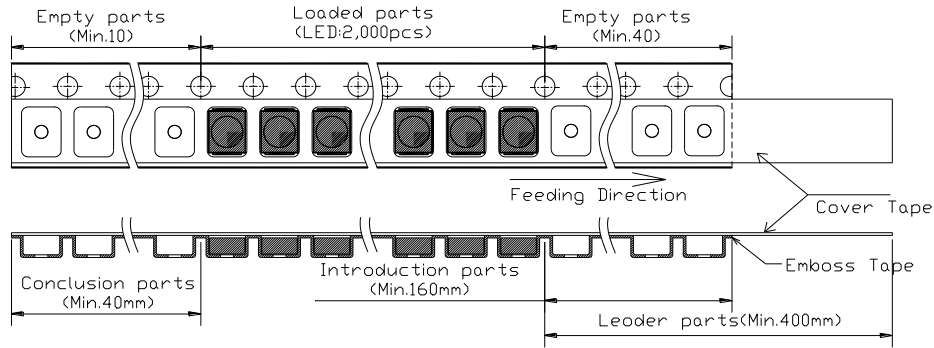

Packaging Specification:

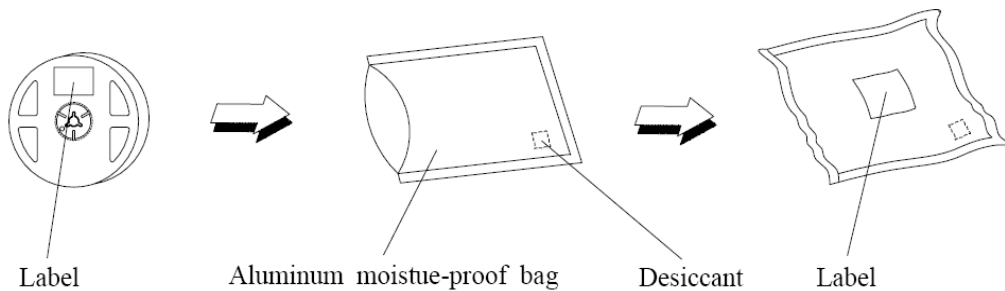

Labeling

Part No: _____
Customer P/N: _____
Item: _____
Q'ty: _____
Vf: _____
Iv: _____
WI: _____
Date: _____

Made in China**Ordering Information**

Part #	Orderable Part #	Spec Range	Quantity per reel
QBLP670-IB	QBLP670-IB	Iv=210mcd typ. @ 20mA/ $\lambda_D=465\text{nm to }475\text{nm}$	2,000 units
QBLP670-IG	QBLP670-IG	Iv=900mcd typ. @ 20mA/ $\lambda_D=520\text{nm to }530\text{nm}$	2,000 units
QBLP670-UV	QBLP670-UV	Iv=125mcd typ. @ 20mA/ $\lambda_P=400\text{nm to }410\text{nm}$	2,000 units
QBLP670-R	QBLP670-R	Iv=230mcd typ. @ 20mA/ $\lambda_D=615\text{nm to }630\text{nm}$	2,000 units
QBLP670-AG	QBLP670-AG	Iv=80mcd typ. @ 20mA/ $\lambda_D=565\text{nm to }576\text{nm}$	2,000 units
QBLP670-Y	QBLP670-Y	Iv=210mcd typ. @ 20mA/ $\lambda_D=585\text{nm to }595\text{nm}$	2,000 units
QBLP670-O	QBLP670-O	Iv=240mcd typ. @ 20mA/ $\lambda_D=600\text{nm to }612\text{nm}$	2,000 units
QBLP670-S	QBLP670-S	Iv=80mcd typ. @ 20mA/ $\lambda_D=630\text{nm to }650\text{nm}$	2,000 units

Revision History

Description:	Revision #	Revision Date
New Release of QBLP670_series	V1.0	09/20/2010
Specification Updates	V2.0	02/03/2011
Amend specification	V2.1	06/01/2011
Green Brightness Updates	V2.2	07/19/2011
Specification Updates	V2.3	01/05/2012
Update Format	V2.4	03/19/2012
Spec updates/ label updates	V3.0	01/30/2013
Add Deep Red Wavelength Bin	V3.1	09/30/2013
Update and add bin info for UV / Update orange min. brightness	V3.2	02/09/2015
Update operating and storage temperature	V3.3	03/09/2016

Disclaimer

QT-BRIGHTTEK reserves the right to make changes without further notice to any products herein to improve reliability, function or design. QT-BRIGHTTEK does not assume any liability arising out of the application or use of any product or circuit described herein; neither does it convey any license under its patent rights, nor the rights of others.

Life Support Policy

QT-BRIGHTTEK's products are not authorized for use as critical components in life support devices or systems without the express written approval of QT-BRIGHTTEK. As used herein:

1. Life support devices or systems are devices or systems which, (a) are intended for surgical implant into the body, or (b) support or sustain life, and (c) whose failure to perform when properly used in accordance with instructions for use provided in the labeling, can be reasonably expected to result in a significant injury of the user.
2. A critical component in any component of a life support device or system whose failure to perform can be reasonably expected to cause the failure of the life support device or system, or to affect its safety or effectiveness.