

ENERGIZER A76

ZEROMERCURY®

MINIATURE ALKALINE



Industry Standard Dimensions

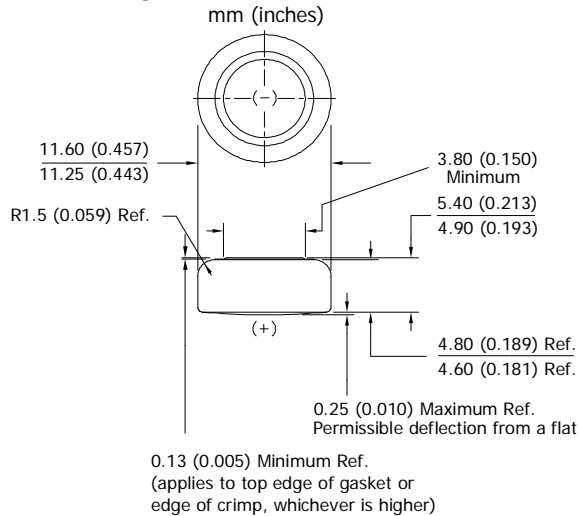

DESIGNED FOR ELECTRONIC APPLICATIONS
WHICH MAY REQUIRE HIGH RATE PULSES

Specifications

- Chemical System:** Manganese Dioxide (MnO₂)
- Designation:** ANSI/NEDA 1166A, IEC-LR44
- Nominal Voltage:** 1.5 Volts
- Typical Capacity:** 118 mAh* (to 0.9 volts)
- Capacity Test:** 6.8K ohm continuous drain at 21°C (70°F)
- Typical Weight:** 2.04 grams (0.08 oz.)
- Typical Volume:** 0.54 cubic centimeters (0.03 cubic inch)
- Impedance (40 Hz):** 3 to 9 ohms
- Max Bulge:** This battery will bulge as it is discharged, but will not exceed the maximum height shown on the battery drawing.

* Varies according to the applied load, temperature, and cutoff voltage.

Cross Section

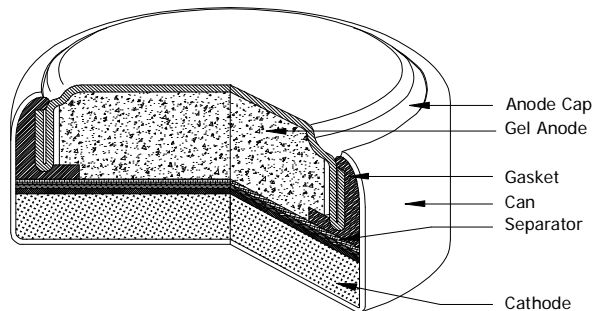

Typical Discharge Characteristics

Typical Performance at 21°C (70°F)

Load: 6.8K ohms - Continuous
Typical Drain @ 1.25V: 0.187 mA
Hours to 0.9V: 642

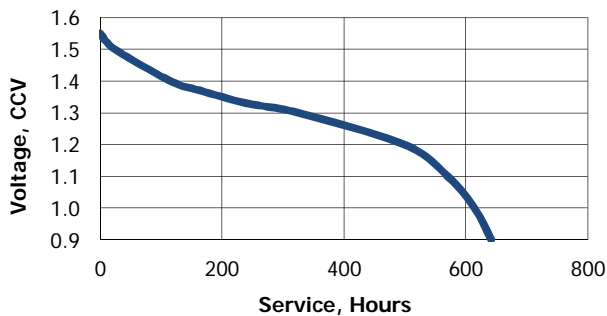

Depth of Discharge

Typical Performance at 21°C (70°F)

Load: 6.8K ohms - Continuous
Typical Drain @ 1.25V: 0.18 mA
Hours to 0.9V: 642

(as percent of capacity)

Temperature	0%	40%	80%
21°C (70°F)	1.55V	1.33V	1.20V

Important Notice

This datasheet contains typical information specific to products manufactured at the time of its publication.
©Energizer Holdings, Inc. - Contents herein do not constitute a warranty.