



PERFORMANCE SPECIFICATION		MIN	TYP	MAX	UNITS
Frequency Range:		50		6000	MHz
Insertion Loss:	50 MHz – 1 GHz		0.1	0.3	dB
	1 GHz – 2 GHz		0.3	0.5	dB
	2 GHz – 4 GHz		1.0	2.0	dB
	4 GHz – 6 GHz		2.0	3.0	dB
Isolation (RF to DC Port):	50 MHz – 1 GHz		50	35	dB
	1 GHz – 2 GHz		30	25	dB
	2 GHz – 4 GHz		25	20	dB
	4 GHz – 6 GHz		22	20	dB
Bias Path Resistance:			0.03	0.05	Ω
Maximum Ratings:					
RF Power:				2	W
DC Port Voltage:				15	V
Input Current:				1	Amps
Operating Temperature Range:		-40		+85	°C
Storage Temperature Range:		-45		+90	°C

**Features:**

- Low Insertion Loss, 0.5 dB Typical at 2 GHz
- Wideband operation, 50 to 6000 MHz
- High Isolation, 35 dB Typical at 1 GHz



<b>Product Control:</b>			
Crystek Part Number:	CBTEE-01-50-6000	Release Date:	04-Aug-2016
Revision Level:	B	Responsible:	C. Vales

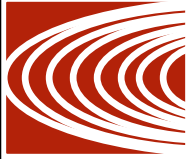

FRONT

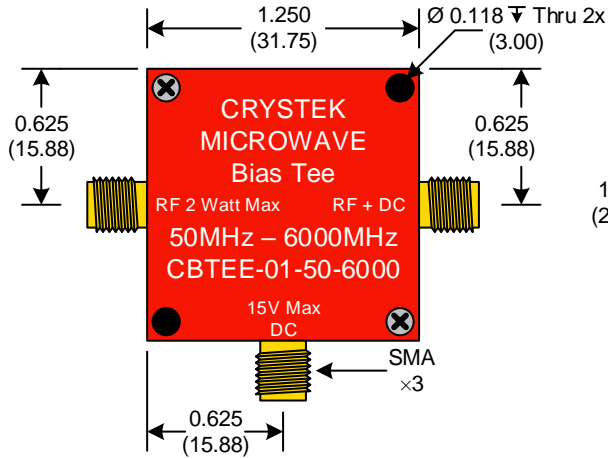

BACK

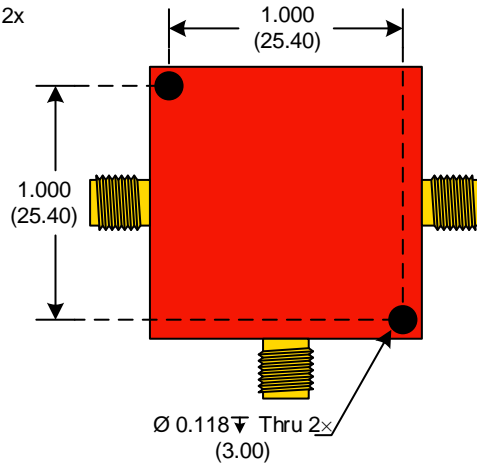

SIDE

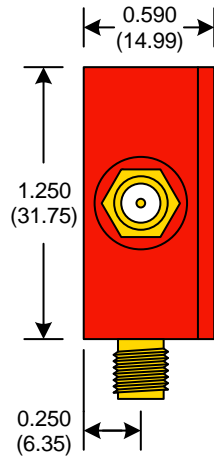

SCHEMATIC

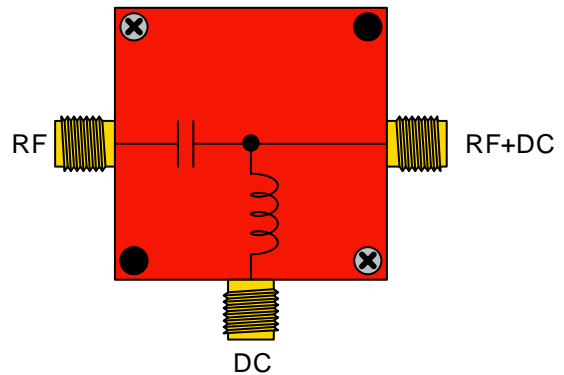

● Unless otherwise specified, Dimensions are in:  $\frac{IN}{(mm)}$

**Product Control:**

Crystek Part Number:	CBTEE-01-50-6000	Release Date:	04-Aug-2016
Revision Level:	B	Responsible:	C. Vales



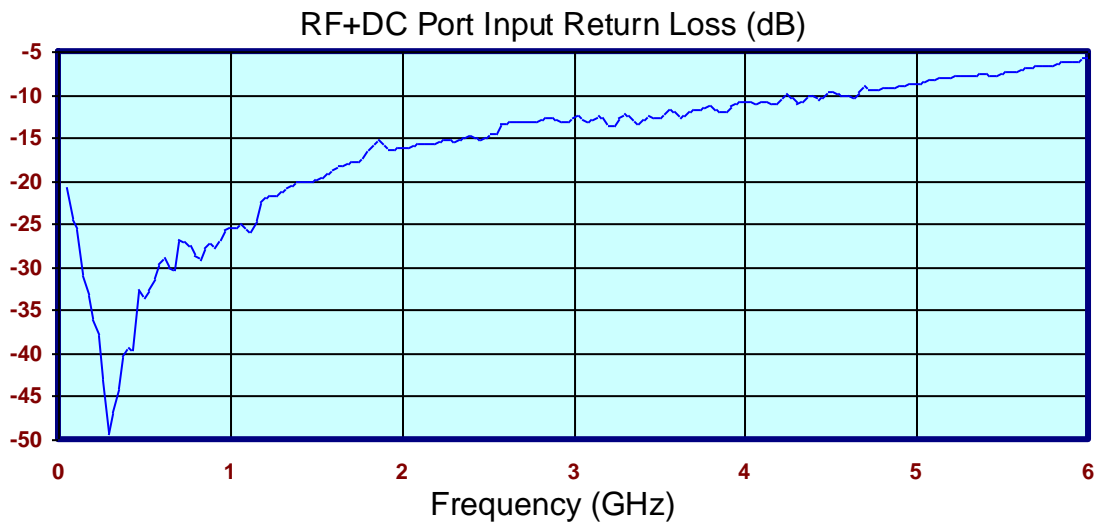
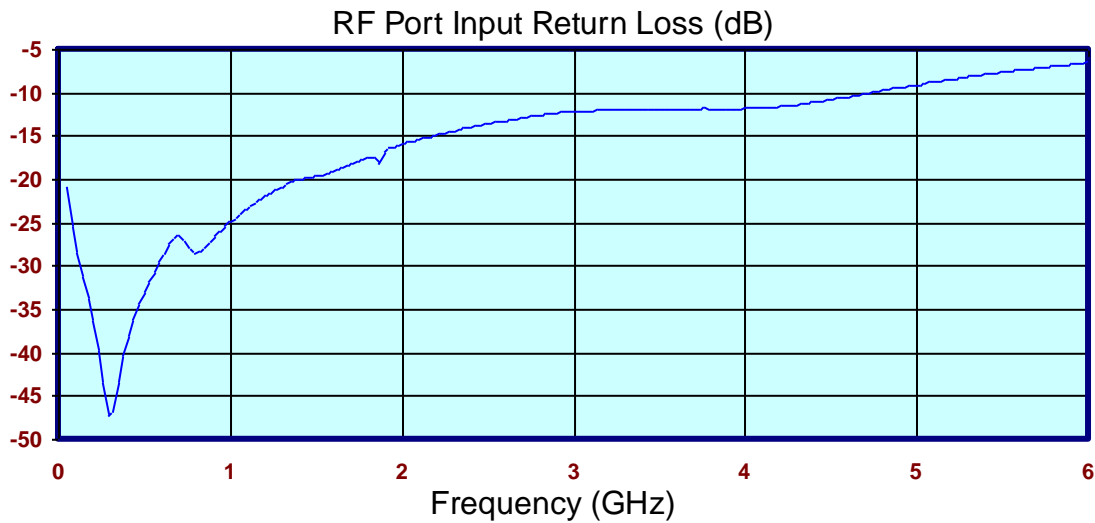
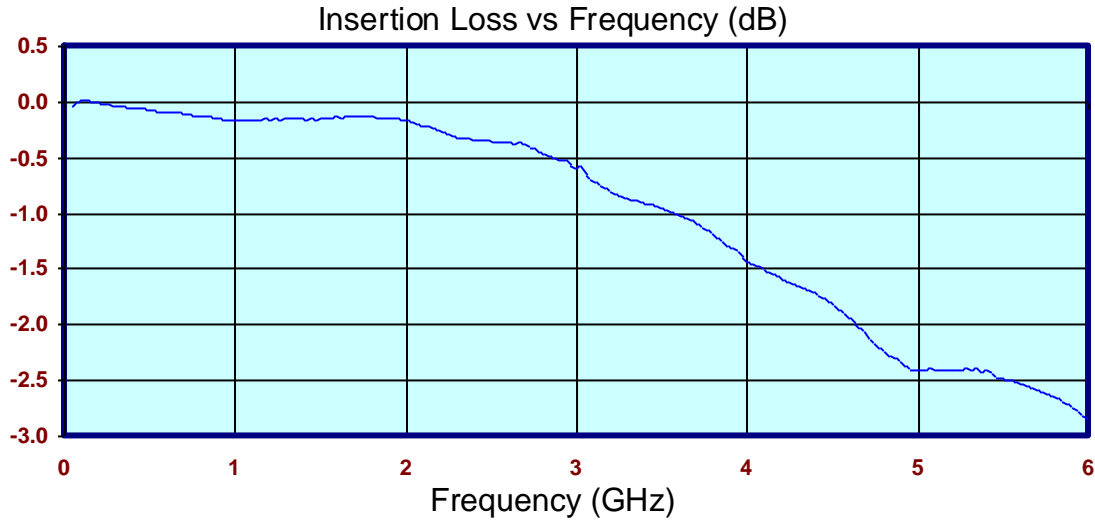
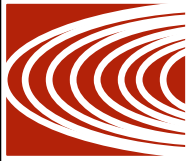

**Product Control:**

Crystek Part Number:	CBTEE-01-50-6000	Release Date:	04-Aug-2016
Revision Level:	B	Responsible:	C. Vales



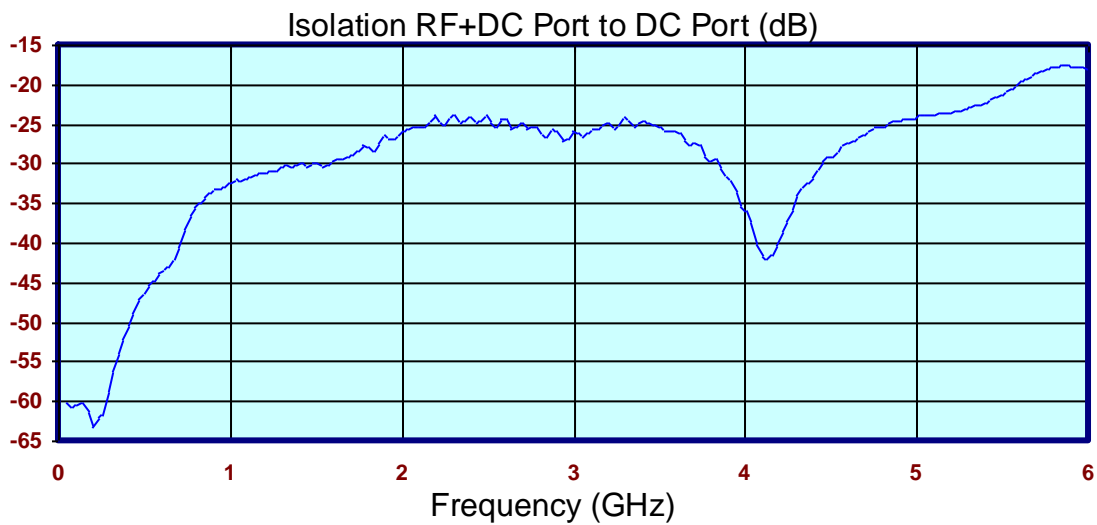
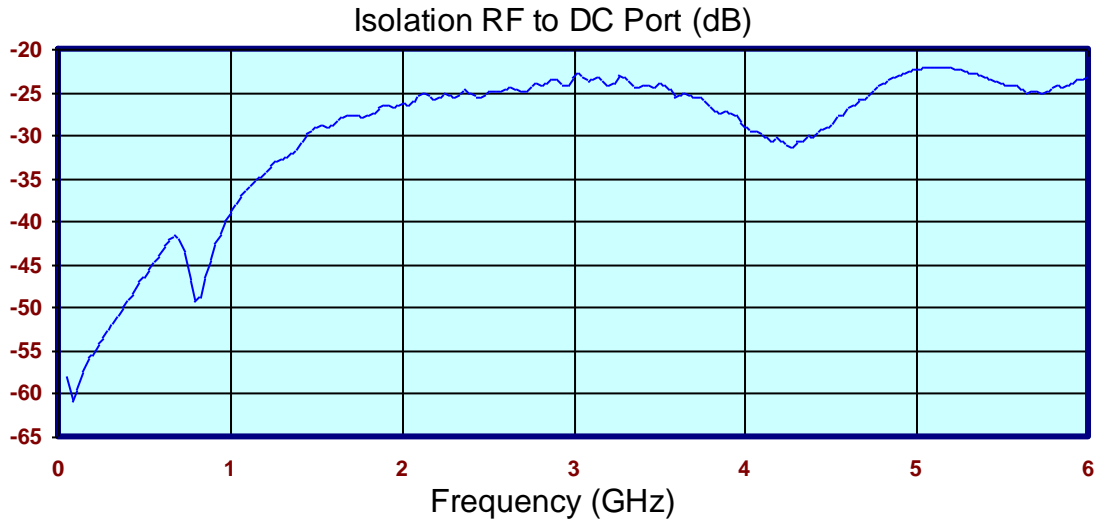
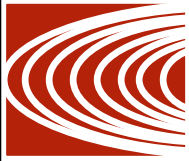

**Product Control:**

Crystek Part Number:	CBTEE-01-50-6000	Release Date:	04-Aug-2016
Revision Level:	B	Responsible:	C. Vales

