



PART NAME

WIDE OPENING EXTERNAL VENT

PART No.

IPV-1116

REV. DATE

4-10-14

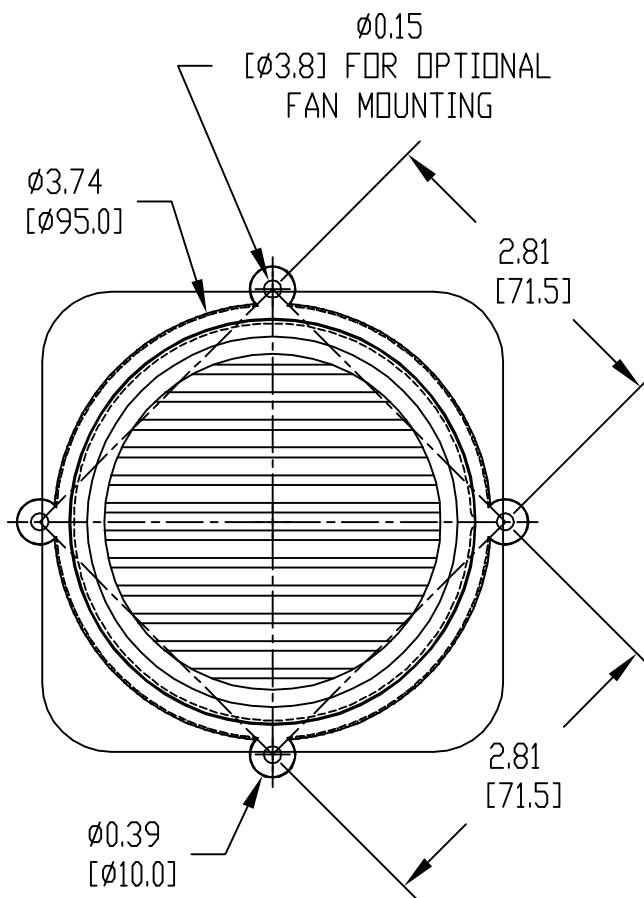
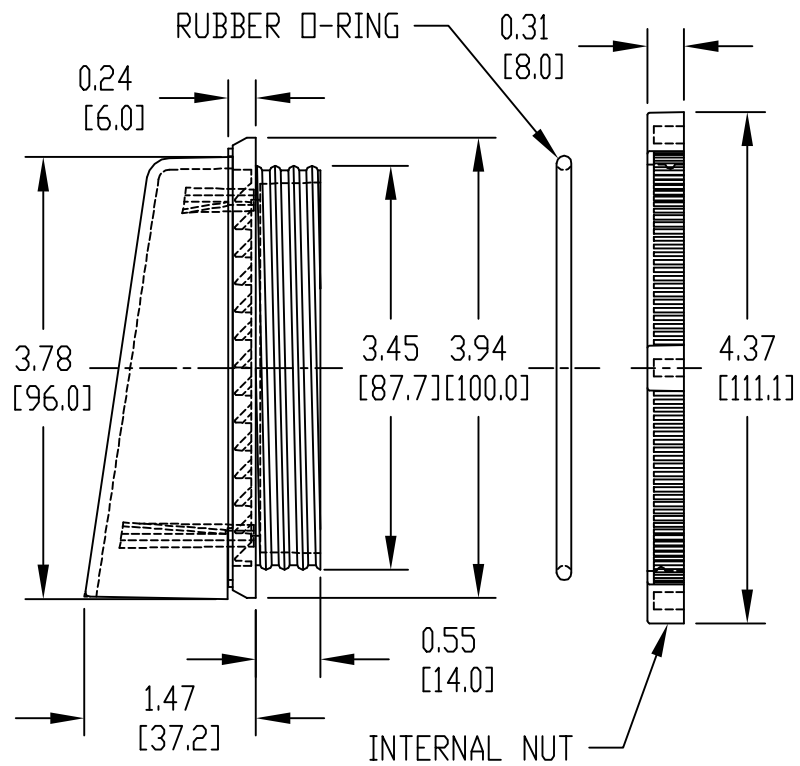
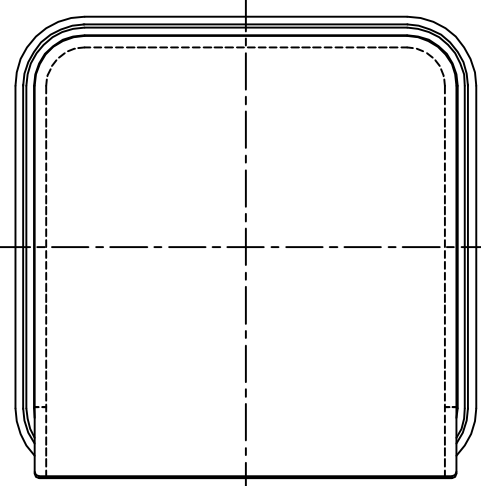
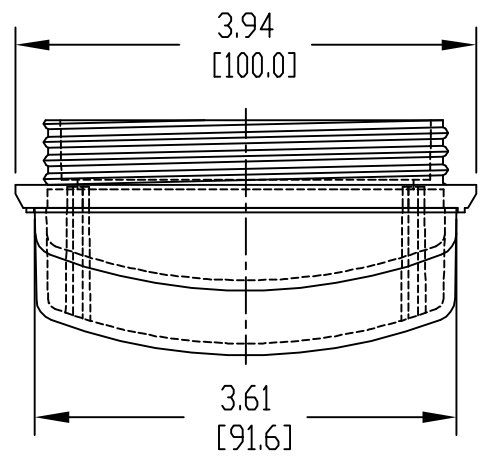

MATERIAL: POLYCARBONATE 10% FIBERGLASS REINFORCED

COLOR: LIGHT GRAY

ALL DIMENSIONS HAVE ±0.03[0.76] TOLERANCE UNLESS OTHERWISE SPECIFIED

DIMENSIONS ARE INCH[MM]

M4 SCREWS LENGTH AS REQUIRED (NOT SUPPLIED)

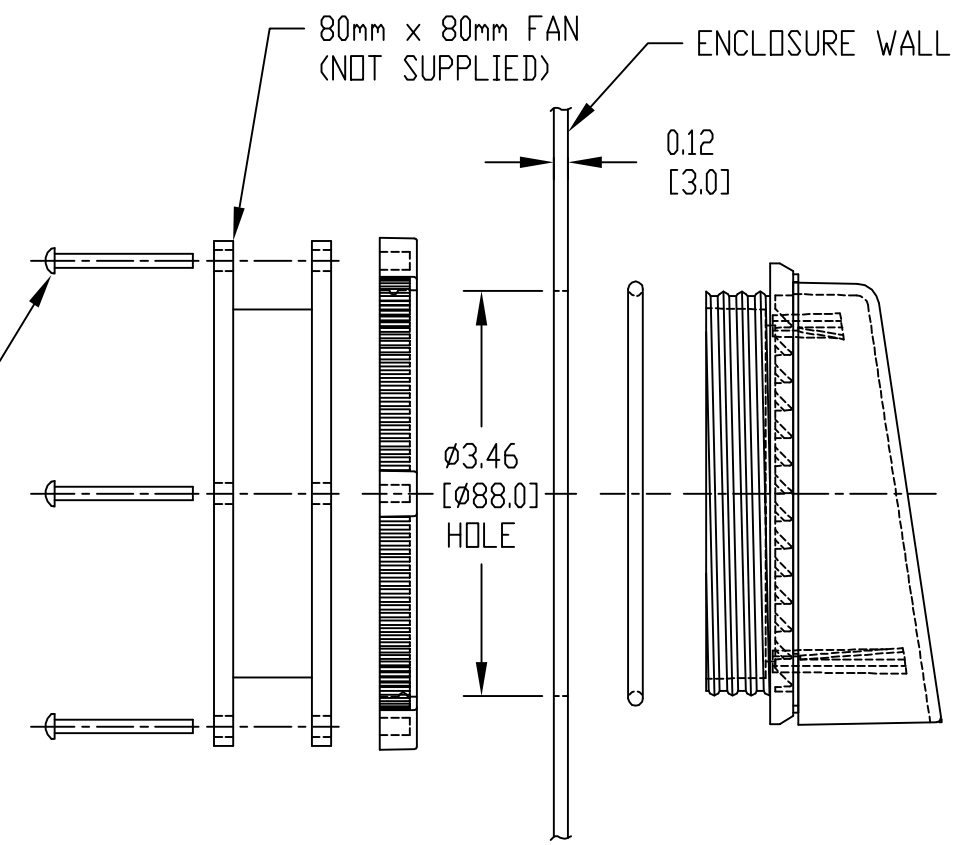

TYPICAL INSTALLATION