

MITSUBISHI IGBT MODULES  
**CM150DU-24H**  
 HIGH POWER SWITCHING USE  
 INSULATED TYPE

**CM150DU-24H**



- Ic ..... 150A
- VCES ..... 1200V
- Insulated Type
- 2-elements in a pack
- UL Recognized

Yellow Card No. E80276  
 File No. E80271

**APPLICATION**

UPS, NC machine, AC-Drive control, Servo, Welders

**OUTLINE DRAWING & CIRCUIT DIAGRAM**

Dimensions in mm

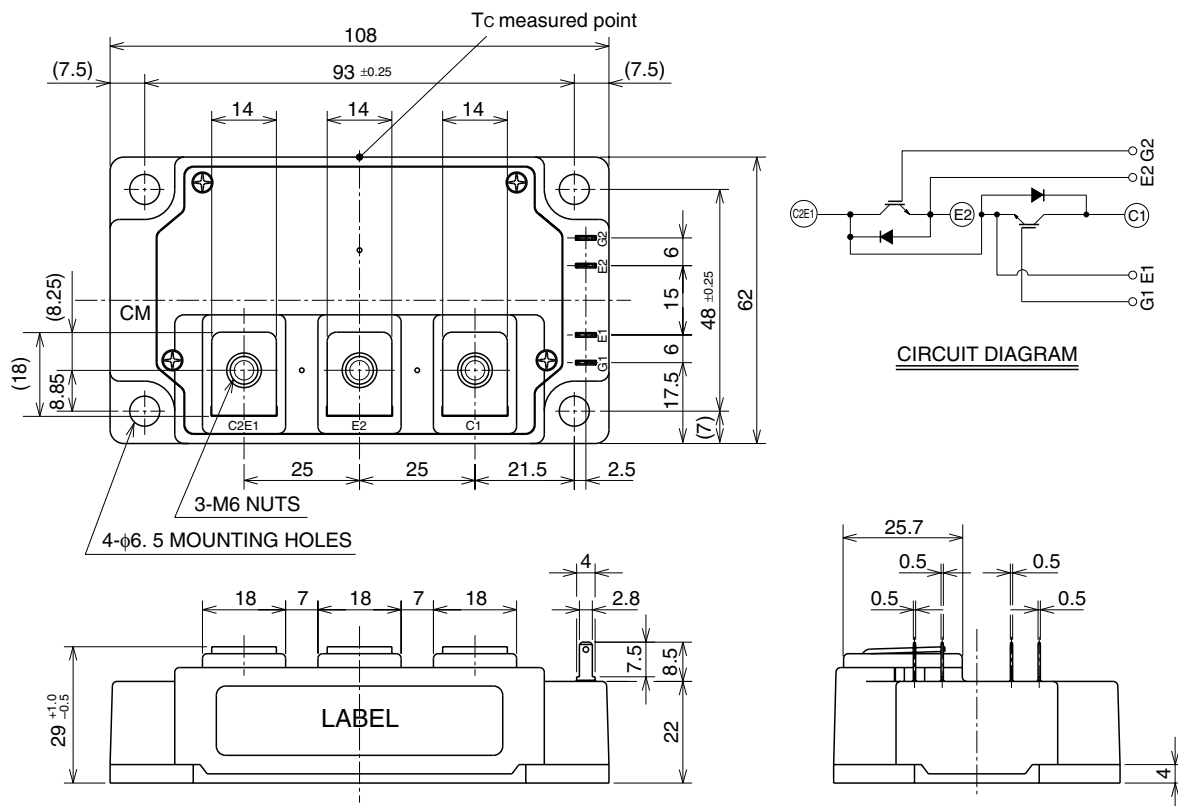

**CM150DU-24H**

**HIGH POWER SWITCHING USE  
INSULATED TYPE**

**MAXIMUM RATINGS (T<sub>j</sub> = 25°C, unless otherwise specified)**

| Symbol                   | Item                          | Conditions  | Ratings    | Unit             |
|--------------------------|-------------------------------|---|------------|------------------|
| V <sub>CE</sub> S        | Collector-emitter voltage     | V <sub>GE</sub> = 0V                              | 1200       | V                |
| V <sub>GE</sub> S        | Gate-emitter voltage          | V <sub>CE</sub> = 0V                              | ±20        | V                |
| I <sub>C</sub>           | Collector current             | T <sub>C</sub> = 25°C                             | 150        | A                |
| I <sub>CM</sub>          |                               | Pulse (Note 1)                                    | 300        | A                |
| I <sub>E</sub> (Note 2)  | Emitter current               | T <sub>C</sub> = 25°C                             | 150        | A                |
| I <sub>EM</sub> (Note 2) |                               | Pulse (Note 1)                                    | 300        | A                |
| P <sub>C</sub> (Note 3)  | Maximum collector dissipation | T <sub>C</sub> = 25°C                             | 890        | W                |
| T <sub>j</sub>           | Junction temperature          | —   | -40 ~ +150 | °C               |
| T <sub>stg</sub>         | Storage temperature           | —   | -40 ~ +125 | °C               |
| V <sub>iso</sub>         | Isolation voltage             | Charged part to base plate, f = 60Hz, AC 1 minute | 2500       | V <sub>rms</sub> |
| —                        | Mounting torque               | Main terminals M6 screw                           | 3.5 ~ 4.5  | N·m              |
|                          |                               | Mounting M6 screw                                 | 3.5 ~ 4.5  | N·m              |
| —                        | Weight                        | Typical value                                     | 400        | g                |

**ELECTRICAL CHARACTERISTICS (T<sub>j</sub> = 25°C, unless otherwise specified)**

| Symbol                   | Item                                 | Test Conditions  | Limits |      |      | Unit |
|--------------------------|--------------------------------------|--|--------|------|------|------|
|                          |                                      |  | Min    | Typ  | Max  |      |
| I <sub>CES</sub>         | Collector cutoff current             | V <sub>CE</sub> = V <sub>CE</sub> S, V <sub>GE</sub> = 0V              | —      | —    | 1    | mA   |
| V <sub>GE(th)</sub>      | Gate-emitter threshold voltage       | I <sub>C</sub> = 15mA, V <sub>CE</sub> = 10V                           | 4.5    | 6    | 7.5  | V    |
| I <sub>GES</sub>         | Gate-leakage current                 | ±V <sub>GE</sub> = V <sub>GES</sub> , V <sub>CE</sub> = 0V             | —      | —    | 0.5  | μA   |
| V <sub>CE(sat)</sub>     | Collector-emitter saturation voltage | I <sub>C</sub> = 150A, V <sub>GE</sub> = 15V (Note 4)                  | —      | 2.9  | 3.7  | V    |
|                          |                                      | T <sub>j</sub> = 125°C   | —      | 2.85 | —    |      |
| C <sub>ies</sub>         | Input capacitance                    | V <sub>CE</sub> = 10V  | —      | —    | 22   | nF   |
| C <sub>oes</sub>         | Output capacitance                   | V <sub>GE</sub> = 0V   | —      | —    | 7.4  | nF   |
| C <sub>res</sub>         | Reverse transfer capacitance         |  | —      | —    | 4.4  | nF   |
| Q <sub>G</sub>           | Total gate charge                    | V <sub>CC</sub> = 600V, I <sub>C</sub> = 150A, V <sub>GE</sub> = 15V   | —      | 560  | —    | nC   |
| t <sub>d(on)</sub>       | Turn-on delay time                   | V <sub>CC</sub> = 600V, I <sub>C</sub> = 150A                          | —      | —    | 200  | ns   |
| t <sub>r</sub>           | Turn-on rise time                    | V <sub>GE</sub> = ±15V   | —      | —    | 250  | ns   |
| t <sub>d(off)</sub>      | Turn-off delay time                  | R <sub>G</sub> = 2.1Ω  | —      | —    | 300  | ns   |
| t <sub>f</sub>           | Turn-off fall time                   | Resistive load   | —      | —    | 350  | ns   |
| V <sub>EC</sub> (Note 2) | Emitter-collector voltage            | I <sub>E</sub> = 150A, V <sub>GE</sub> = 0V                            | —      | —    | 3.2  | V    |
| t <sub>rr</sub> (Note 2) | Reverse recovery time                | I <sub>E</sub> = 150A,   | —      | —    | 300  | ns   |
| Q <sub>rr</sub> (Note 2) | Reverse recovery charge              | die / dt = -300A / μs  | —      | 0.82 | —    | μC   |
| R <sub>th(j-c)Q</sub>    | Thermal resistance (Note 5)          | Junction to case, IGBT part (Per 1/2 module)                           | —      | —    | 0.14 | K/W  |
| R <sub>th(j-c)R</sub>    |                                      | Junction to case, FWDi part (Per 1/2 module)                           | —      | —    | 0.24 | K/W  |
| R <sub>th(c-f)</sub>     | Contact thermal resistance           | Case to heat sink, conductive grease applied (Per 1/2 module) (Note 6) | —      | 0.04 | —    | K/W  |

- Note 1. Pulse width and repetition rate should be such that the device junction temperature (T<sub>j</sub>) does not exceed T<sub>jmax</sub> rating.  
 2. I<sub>E</sub>, I<sub>EM</sub>, V<sub>EC</sub>, t<sub>rr</sub>, Q<sub>rr</sub> & die/dt represent characteristics of the anti-parallel, emitter-collector free-wheel diode.  
 3. Junction temperature (T<sub>j</sub>) should not increase beyond 150°C.  
 4. Pulse width and repetition rate should be such as to cause negligible temperature rise.  
 5. Case temperature (T<sub>C</sub>) measured point is shown in page OUTLINE DRAWING.  
 6. Typical value is measured by using thermally conductive grease of λ = 0.9[W/(m · K)].

# CM150DU-24H

HIGH POWER SWITCHING USE  
INSULATED TYPE

## PERFORMANCE CURVES

**OUTPUT CHARACTERISTICS (TYPICAL)**

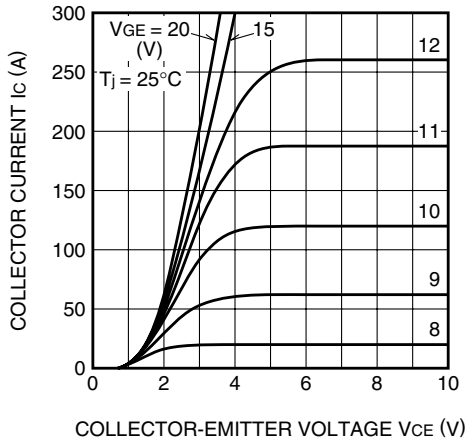

**TRANSFER CHARACTERISTICS (TYPICAL)**

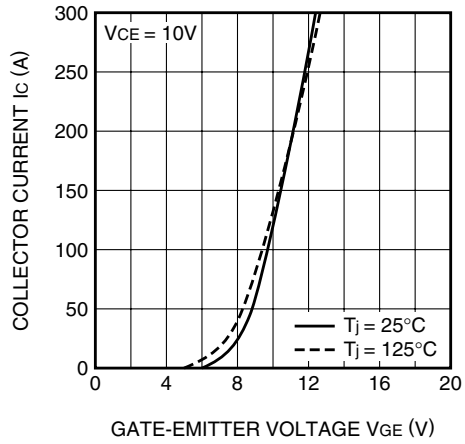

**COLLECTOR-EMITTER SATURATION VOLTAGE CHARACTERISTICS (TYPICAL)**

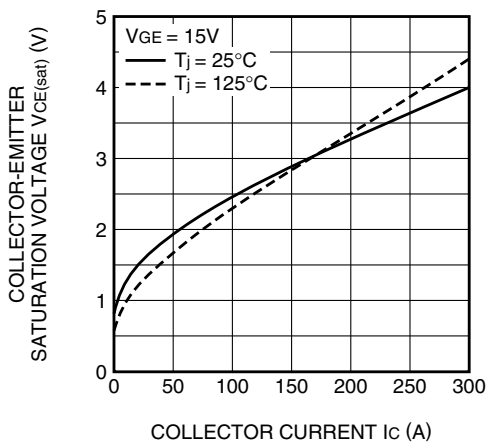

**COLLECTOR-EMITTER SATURATION VOLTAGE CHARACTERISTICS (TYPICAL)**

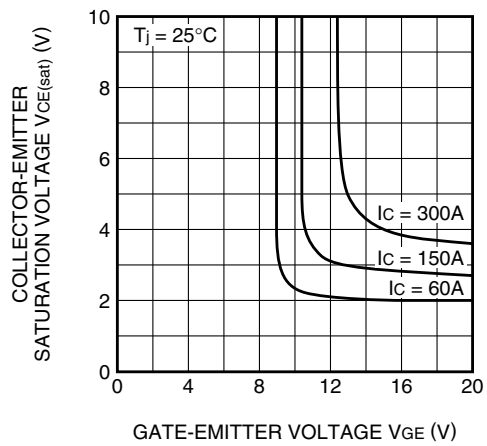

**FREE-WHEEL DIODE FORWARD CHARACTERISTICS (TYPICAL)**

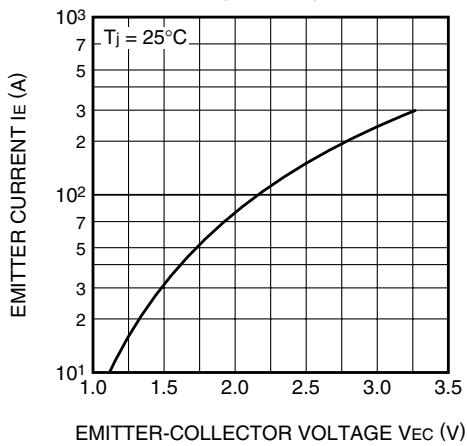

**CAPACITANCE CHARACTERISTICS (TYPICAL)**

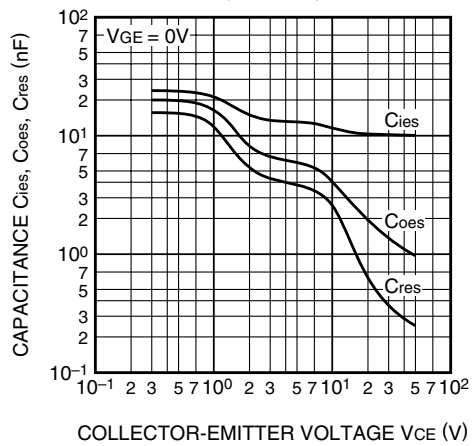

# CM150DU-24H

HIGH POWER SWITCHING USE  
INSULATED TYPE

**HALF-BRIDGE  
SWITCHING TIME CHARACTERISTICS  
(TYPICAL)**

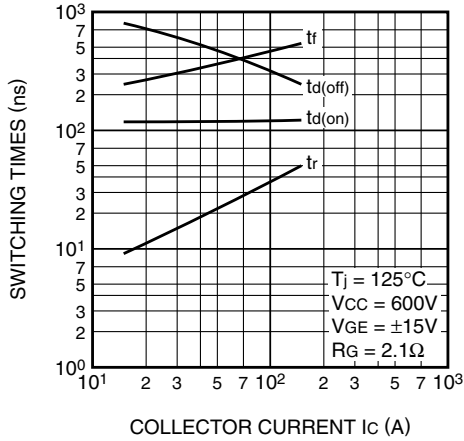

**REVERSE RECOVERY CHARACTERISTICS  
OF FREE-WHEEL DIODE  
(TYPICAL)**

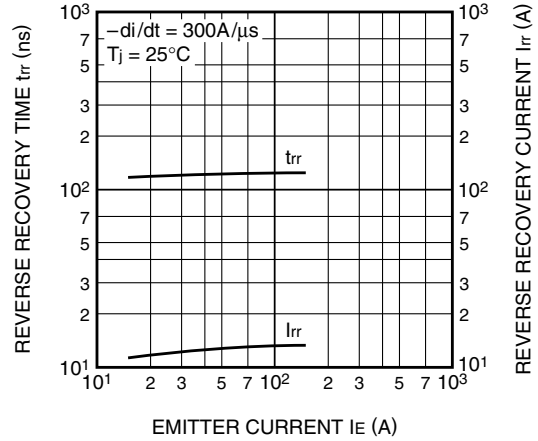

**TRANSIENT THERMAL  
IMPEDANCE CHARACTERISTICS  
(IGBT part)**

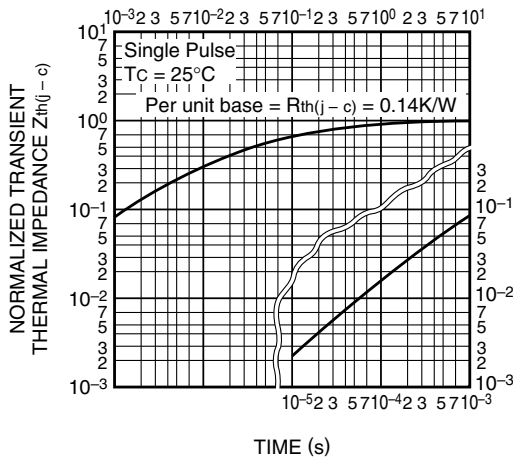

**TRANSIENT THERMAL  
IMPEDANCE CHARACTERISTICS  
(FWDi part)**

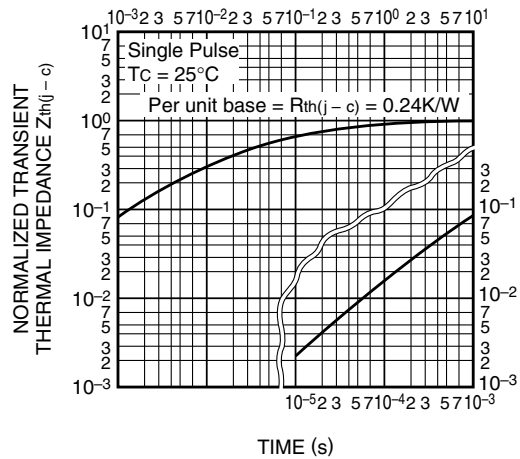

**GATE CHARGE CHARACTERISTICS  
(TYPICAL)**

