

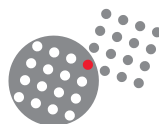

Lightweight and sealed

The solution for indoor applications
using 1 standard AWG16 contact

- | | | |
|--------------------------------|---|--------------------------|
| Secure for indoor applications | ✓ | Flame retardant material |
| Water jet & underwater proof | ✓ | IP68/IP69K |
| Easy to handle | ✓ | Ergonomic design |
| Wire sealing | ✓ | Grommet option |
| High contact density | ✓ | Up to 23 contacts #16 |



SOURIAU on the railway market



Standard

The SOURIAU solution offers a wide range of connector layouts providing a simplified process from purchasing to harnessing: 1 type of contact to order, to manage, to stock, to crimp for a wide range of connectors.

SOURIAU's standardisation policy is the best compromise between technology and cost.



High Speed

SOURIAU connectors ensure the continuity of the network with railway qualified connectors integrating new technologies: copper contacts, Quadrax and fibre optics to transfer high speed Ethernet and other data protocols.



E & S

SOURIAU, along with its customers is committed to the research of energy efficiency and sustainability.

The use of lightweight materials, fiber optics and high contact density contribute to the weight reduction of train equipments and help railway operators to save energy.



Technical features

- Housing: thermoplastic
- ≥ 500 hours salt spray resistant
- Bayonet coupling
- Mating cycles: 250 mating cycles
- Vibration & shocks: sinusoidal vibrations per CEI 60512-4 from 1 to 2000Hz
- Max current per contact: 15Amps
- Insulation resistance: 5000M Ω
- Withstanding voltage: 2550Vac following NFF 61030
- Flammability rating: UL94-VO, I2F3/I3F2 following NFF 16-101 / 16-102
- Sealing: IP68/69K with suitable accessories
- Operating temperature: -40°C / +105°C
40/100/21 per NFF 61-030

Rated insulation voltage U_{Nm} * according to EN 50-124-1: "Railway applications - Insulation coordination".

The rated insulation voltage U_{Nm} * is given per layout according to:

- overvoltage level:
 - OV3 means a 2500V rated impulse voltage
- pollution degree of the environment:
 - PD2 means only non conductive pollution occurs except that occasionally a temporary conductivity caused by condensation is to be expected
 - PD3 means conductive pollution occurs or dry non conductive pollution occurs which becomes conductive due to condensation which is to be expected
- creepage and clearance, depending on the insert and the type of the contacts used:
 - for layouts that use AWG16 contacts we recommend to use shorter female contacts (RC16M23GE7K) to reach a higher operating voltage level.

U_{Nm} * is not the working voltage.

U_{Nm} * has to be chosen according to the voltage of the power supply U_n .

*Definition of U_{Nm} rated insulation voltage (EN 50-124-1): r.m.s. withstand voltage value assigned by the manufacturer to the equipment or to a part of it, characterizing the specified (long-term) withstand capability of its insulation. NOTE: The rated insulation voltage is not necessarily equal to the-rated voltage of equipment which is primarily related to functional performance.

Example for a battery supply system:

Power supply Voltage U_n	Minimum rated insulation voltage U_{Nm} of the electrical circuit on:	
	Rolling stock (kV)	Fixed installations (kV)
Battery supply system (V)		
24 & 36	0.05	0.05
48 & 72	0.1	0.1
110 & 120	0.15	0.15

Extract from EN50-124-1 Appendix D

For more details please refer to UTS catalog.

Ordering information

	UTS	0	14	12	S	N
	UTS	1	14	12	P	N
	UTS	6	14	12	P	N
	UTS	7	14	12	S	N
Shell style:						
0: Square flange receptacle						
1: In line receptacle						
6: Cable plug						
7: Jam nut receptacle						
Shell size:						
10 – 12 – 14 – 16 – 18						
Contact layout: see page 4						
Contact type:						
P: Pin						
S: Socket						
Orientation:						
No letter: standard version						
W,X,Y,Z: different orientations (consult factory)						



Contact layouts

Size 10

10-3

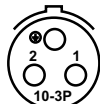

3Ø1.6 (#16)

U_{Nm}

300V - OV3 - PD2
220V - OV3 - PD3

10-4

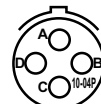

4Ø1.6 (#16)

U_{Nm}

150V - OV3 - PD2
150V - OV3 - PD3

102W2



2Ø2.4 (#12)
2Ø1.0 (#20)

U_{Nm}

300V - OV3 - PD2
220V - OV3 - PD3

Size 12

12-4



4Ø1.6 (#16)

U_{Nm}

300V - OV3 - PD2
260V - OV3 - PD3

12-8

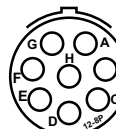

8Ø1.6 (#16)

U_{Nm}

150V - OV3 - PD2
100V - OV3 - PD3

Size 14

142G1

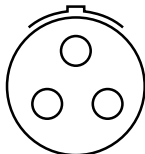

3Ø3.6 (#8)

U_{Nm}

300V - OV3 - PD2
220V - OV3 - PD3

14-7

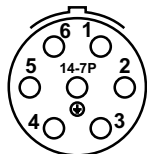

7Ø1.6 (#16)

U_{Nm}

300V - OV3 - PD2
260V - OV3 - PD3

14-12

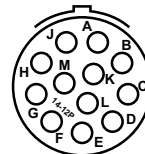

12Ø1.6 (#16)

U_{Nm}

150V - OV3 - PD2
80V - OV3 - PD3

Size 18

18-23

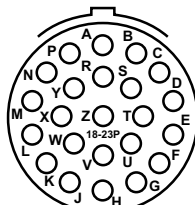

23Ø1.6 (#16)

U_{Nm}

150V - OV3 - PD2
80V - OV3 - PD3



Receptacle

Square flange receptacle

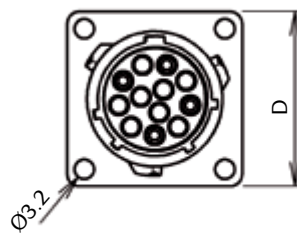
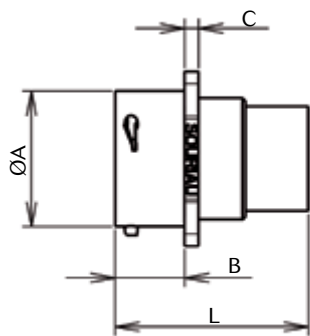

Front view

Part number	Shell size	L	ØA	B	C	D
For male contacts						
UTS0104P	10	31.7	15	11.35	2.3	23.8
UTS0124P	12		19			26.2
UTS0128P			22.2			28.6
UTS01412P	14		28.5		2.5	33.3
UTS01823P	18					

Part number	Shell size	L	ØA	B	C	D
For female contacts						
UTS0104S	10	31.7	15	11.35	2.3	23.8
UTS0128S	12		19			26.2
UTS01412S			22.2			28.6
UTS01823S	14		28.5		2.5	33.3
	18					

Note : all dimensions are in mm



Jam nut receptacle

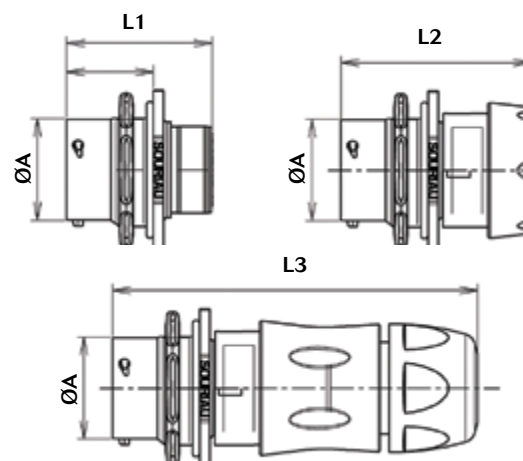

Part number	Shell size	L1	L2	L3	ØA	B	C	D	Connector type	Termination
For male contacts										
UTS7103P	10	33.9			14.9	19.3	27	22.2	UTS standard	
UTS7104P					19		31.8	27		
UTS7102W2P					19		31.8	27		
UTS7124P	12	35.75		22.2	34.9		30.2			
UTS7127P					34.9		30.2			
UTS7142G1P	14	33.9		22.2	28.5		41.3	36.6		
UTS7147P					27		22.2			
UTS71412P					27		22.2			
UTS71823P	18				28.5		41.3	36.6		
UTS7GN104P	10		41		14.9		27	22.2		
UTS7GN128P	12		40.7		19	31.8	27			
UTS7GN147P	14		43		22.2	34.9	30.2			
UTS7GN1412P	14				22.2	34.9	30.2	Discrete wire sealing	Cable gland and grommet	
UTS7GJC104P	10			70.5	14.9	27	22.2			
UTS7GJC128P	12			74	19	31.8	27			
UTS7GJC147P	14			80.5	22.2	34.9	30.2			
UTS7GJC1412P	14			80.5	22.2	34.9	30.2			

Part number	Shell size	L1	L2	L3	ØA	B	C	D	Connector type
For male contacts									
UTS7103S	10	33.9			14.9	19.3	27	22.2	UTS standard
UTS7104S					19		31.8	27	
UTS7102W2S					19		31.8	27	
UTS7124S	12	33.9	-	-	22.2		34.9	30.2	
UTS7127S					22.2		34.9	30.2	
UTS7142G1S	14	33.9	-	-	22.2		34.9	30.2	
UTS7147S					22.2		34.9	30.2	
UTS71412S					22.2		34.9	30.2	
UTS71823S	18				28.5		41.3	36.6	

Note : all dimensions are in mm



Plug

Plug with cable gland

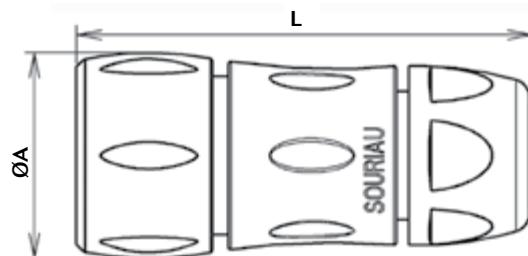

Part number		Shell size	L	ØA	Termination
For male contacts	For female contacts				
UTS6JC103P	UTS6JC103S	10	63.2	26.7	Cable gland
UTS6JC104P	UTS6JC104S				
UTS6JC102W2P	UTS6JC102W2S				
UTS6JC124P	UTS6JC124S	12	66.7	30.2	
UTS6JC128P	UTS6JC128S				
UTS6JC142G1P	UTS6JC142G1S	14	71.5	35.1	
UTS6JC147P	UTS6JC147S				
UTS6JC1412P	UTS6JC1412S				
UTS6JC1823P	UTS6JC1823S	18	81.3	42	

Plug with grommet

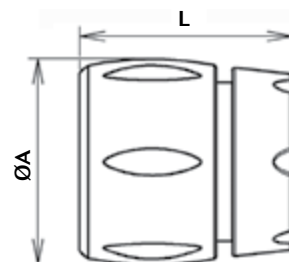

Part number		Shell size	L	ØA	Termination
Only available for female contacts					
UTS6GN104S		10	32	26.2	Nut & grommet
UTS6GN128S		12	32.3	29.7	
UTS6GN147S		14	32	34.6	
UTS6GN1412S					
UTS6GJC104S		10	61.5	26.2	Cable gland & grommet
UTS6GJC128S		12	64.5	29.7	
UTS6GJC147S		14	70	34.6	
UTS6GJC1412S					

Note : all dimensions are in mm



In line receptacle

In line receptacle with accessories

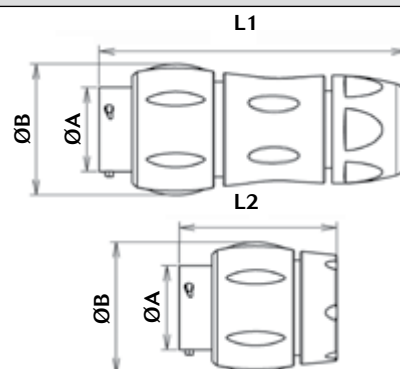

Part number	Shell size	L1	L2	ØA	ØB	Connector type	Termination
For male contacts							
UTS1JC103P	10	70		14.9	26.7	UTS standard	
UTS1JC104P				19	30.1		
UTS1JC102W2P							
UTS1JC124P	12	74		22.2	35.1		
UTS1JC127P							
UTS1JC142G1P	14	78.5		28.5	42		
UTS1JC147P							
UTS1JC1412P							
UTS1JC1823P	18	89					
UTS1GN104P	10		40.9	14.9	26.2	Discrete wire sealing	Nut and grommet
UTS1GN128P	12		40.9	19	29.7		
UTS1GN147P	14		43	22.2	34.6		
UTS1GN1412P							
UTS1GJC104P	10	70.7		14.9	26.2	Cable gland and grommet	
UTS1GJC128P	12	74.5		19	29.7		
UTS1GJC147P	14	80.5		22.2	34.6		
UTS1GJC1412P							

Part number	Shell size	L1	L2	ØA	ØB	Connector type	Termination
For female contacts							
UTS1JC103S	10	70		14.9	26.7	UTS standard	
UTS1JC104S				19	30.1		
UTS1JC102W2S							
UTS1JC124S	12	74		22.2	35.1		
UTS1JC127S							
UTS1JC142G1S	14	78.5		28.5	42		
UTS1JC147S							
UTS1JC1412S							
UTS1JC1823S	18	89					

For further information, click here www.railway-connectors.com
Or contact us click here contactindustry@souriau.com

Note : all dimensions are in mm