

\*RoHS COMPLIANT

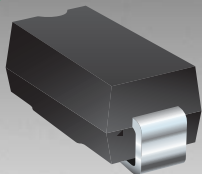

**BOURNS®**

## Features

- RoHS compliant\*
- Glass passivated chip
- Low reverse leakage current
- Low forward voltage drop
- High current capability

## CD214A-R150~R1200 Glass Passivated Rectifiers

### General Information

The markets of portable communications, computing and video equipment are challenging the semiconductor industry to develop increasingly smaller electronic components. Bourns offers Glass Passivated Rectifiers for rectification applications, in compact chip DO-214AC (SMA) size format, which offer PCB real estate savings and are considerably smaller than most competitive parts. The Glass Passivated Rectifier Diodes offer a forward current of 1 A with a choice of repetitive peak reverse voltage of 50 V up to 2000 V.

Bourns® Chip Diodes conform to JEDEC standards, are easy to handle on standard pick and place equipment and their flat configuration minimizes roll away.

### Electrical Characteristics (@ T<sub>A</sub> = 25 °C Unless Otherwise Noted)

Parameter	Symbol	CD214A-					Unit
		R150	R1100	R1200	R1400	R1600	
Maximum Repetitive Peak Reverse Voltage	V <sub>RRM</sub>	50	100	200	400	600	V
Maximum RMS Voltage	V <sub>RMS</sub>	35	70	140	280	420	V
Maximum DC Blocking Voltage	V <sub>DC</sub>	50	100	200	400	600	V
Max. Average Forward Rectified Current <sup>1</sup>	I <sub>(AV)</sub>	1.0					A
DC Reverse Current @ Rated DC Blocking Voltage (@T <sub>J</sub> = 25 °C)	I <sub>R</sub>	5.0					μA
DC Reverse Current @ Rated DC Blocking Voltage (@T <sub>J</sub> = 125 °C)	I <sub>R</sub>	30					μA
DC Reverse Current @ Rated DC Blocking Voltage (@T <sub>J</sub> = 150 °C)	I <sub>R</sub>	50					μA
Typical Junction Capacitance <sup>2</sup>	C <sub>J</sub>	12					pF
Maximum Instantaneous Forward Voltage @ 1 A	V <sub>F</sub>	1.0					V
Typical Thermal Resistance <sup>3</sup>	R <sub>θJA</sub> R <sub>θJL</sub>	75 27					°C/W °C/W
Peak forward surge current 8.3 ms single half sine-wave superimposed on rated load (JEDEC Method)	I <sub>FSM</sub>	30					A

Notes:

1 See Forward Derating Curve.

2 Measured @ 1.0 MHz and applied reverse voltage of 4.0 VDC.

3 Thermal resistance from junction to ambient and from junction to lead P.C.B. mounted on 0.2 ~ x 0.2 ~ (5.0 mm x 5.0 mm) copper pad areas.

\*RoHS Directive 2002/95/EC Jan. 27, 2003 including annex and RoHS Recast 2011/65/EU June 8, 2011.

Specifications are subject to change without notice.

The device characteristics and parameters in this data sheet can and do vary in different applications and actual device performance may vary over time.

Users should verify actual device performance in their specific applications.

# CD214A-R150~R12000 Glass Passivated Rectifiers

**BOURNS®**

## Electrical Characteristics (@ $T_A = 25\text{ }^\circ\text{C}$ Unless Otherwise Noted)

Parameter	Symbol	CD214A-						Unit
		R1800	R11000	R11100	R11200	R11600	R12000	
Maximum Repetitive Peak Reverse Voltage	$V_{RRM}$	800	1000	1100	1200	1600	2000	V
Maximum RMS Voltage	$V_{RMS}$	560	700	770	840	1120	1400	V
Maximum DC Blocking Voltage	$V_{DC}$	800	1000	1100	1200	1600	2000	V
Max. Average Forward Rectified Current <sup>1</sup>	$I_{(AV)}$	1.0						A
DC Reverse Current @ Rated DC Blocking Voltage (@ $T_J = 25\text{ }^\circ\text{C}$ )	$I_R$	5.0						$\mu\text{A}$
DC Reverse Current @ Rated DC Blocking Voltage (@ $T_J = 125\text{ }^\circ\text{C}$ )	$I_R$	30		50			$\mu\text{A}$	
Typ. Junction Capacitance <sup>2</sup>	$C_J$	12						pF
Maximum Instantaneous Forward Voltage @ 1 A	$V_F$	1.0		1.25			2.0	V
Typical Thermal Resistance <sup>3</sup>	$R_{\theta JA}$	75						$^\circ\text{C/W}$
	$R_{\theta JL}$	27						$^\circ\text{C/W}$
Peak forward surge current 8.3 ms single half sine-wave superimposed on rated load (JEDEC Method)	$I_{FSM}$	30		25			25	A

Notes:

1 See Forward Derating Curve.

2 Measured @ 1.0 MHz and applied reverse voltage of 4.0 VDC.

3 Thermal resistance from junction to ambient and from junction to lead P.C.B. mounted on 0.2" x 0.2" (5.0 mm x 5.0 mm) copper pad areas.

## Thermal Characteristics (@ $T_A = 25\text{ }^\circ\text{C}$ Unless Otherwise Noted)

Parameter	Symbol	CD214A-R150~R12000	Unit
Operating Temperature Range	$T_J$	-65 to +175	$^\circ\text{C}$
Storage Temperature Range	$T_{STG}$	-65 to +175	$^\circ\text{C}$

Specifications are subject to change without notice.

The device characteristics and parameters in this data sheet can and do vary in different applications and actual device performance may vary over time.

Users should verify actual device performance in their specific applications.

# CD214A-R150~R12000 Glass Passivated Rectifiers



## Product Dimensions

This is an RoHS compliant molded plastic package. The polarity is indicated by a cathode band and weighs approximately 0.064 g. The package and dimensions are shown below.

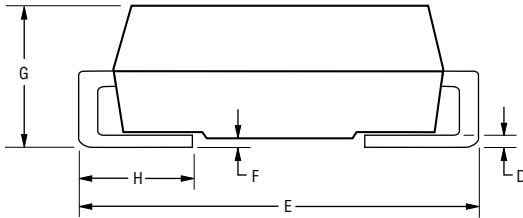
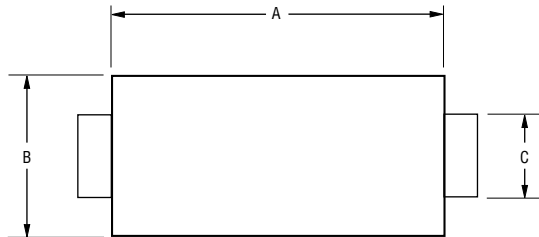

DIMENSIONS:  $\frac{\text{MM}}{\text{(INCHES)}}$

Dimensions	DO-214AC (SMA)
A	$\frac{4.06 - 4.57}{(0.160 - 0.180)}$
B	$\frac{2.29 - 2.92}{(0.090 - 0.115)}$
C	$\frac{1.27 - 1.63}{(0.050 - 0.064)}$
D	$\frac{0.15 - 0.31}{(0.006 - 0.112)}$
E	$\frac{4.83 - 5.59}{(0.190 - 0.220)}$
F	$\frac{0.05 - 0.20}{(0.002 - 0.008)}$
G	$\frac{2.01 - 2.62}{(0.080 - 0.103)}$
H	$\frac{0.76 - 1.52}{(0.030 - 0.060)}$

## Recommended Pad Layout

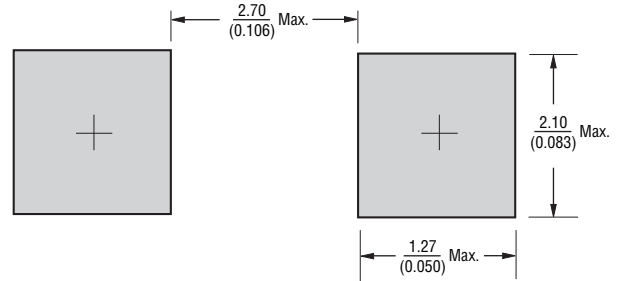

DIMENSIONS:  $\frac{\text{MM}}{\text{(INCHES)}}$

## Physical Specifications

Case .....Molded plastic per UL Class 94V-0  
 Polarity .....Band indicates diode cathode  
 Weight .....0.002 ounces / 0.064 grams

## How To Order

**CD 214A - R 1 50**

Common Code \_\_\_\_\_  
 Chip Diode \_\_\_\_\_  
 Package \_\_\_\_\_  
 • 214A = SMA/DO-214AC \_\_\_\_\_  
 Model \_\_\_\_\_  
 R = Glass Passivated Rectifiers \_\_\_\_\_  
 Forward Current  $I_{(AV)}$  \_\_\_\_\_  
 1 = 1 A \_\_\_\_\_  
 Reverse Voltage \_\_\_\_\_  
 50 = 50 V                      1000 = 1000 V  
 100 = 100 V                    1100 = 1100 V  
 200 = 200 V                    1200 = 1200 V  
 400 = 400 V                    1600 = 1600 V  
 600 = 600 V                    2000 = 2000 V  
 800 = 800 V

## Typical Part Marking

CD214A-R150 .....	<b>B</b> R1A
CD214A-R1100 .....	<b>B</b> R1B
CD214A-R1200 .....	<b>B</b> R1D
CD214A-R1400 .....	<b>B</b> R1G
CD214A-R1600 .....	<b>B</b> R1J
CD214A-R1800 .....	<b>B</b> R1K
CD214A-R11000 .....	<b>B</b> R1M
CD214A-R11100 .....	<b>B</b> R1N
CD214A-R11200 .....	<b>B</b> R1Q
CD214A-R11600 .....	<b>B</b> R1Y
CD214A-R12000 .....	<b>B</b> R1Z

Specifications are subject to change without notice.

The device characteristics and parameters in this data sheet can and do vary in different applications and actual device performance may vary over time. Users should verify actual device performance in their specific applications.

# CD214A-R150~R12000 Glass Passivated Rectifiers



## Rating and Characteristic Curves

### Forward Current Derating Curve

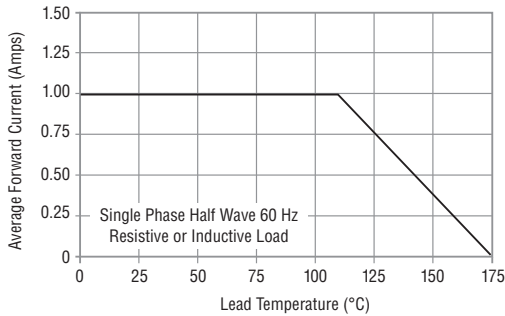

### Non-Repetitive Surge Current

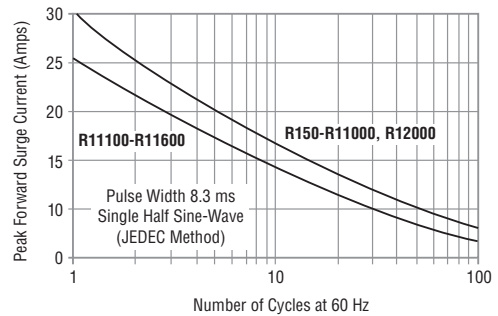

### Forward Characteristics

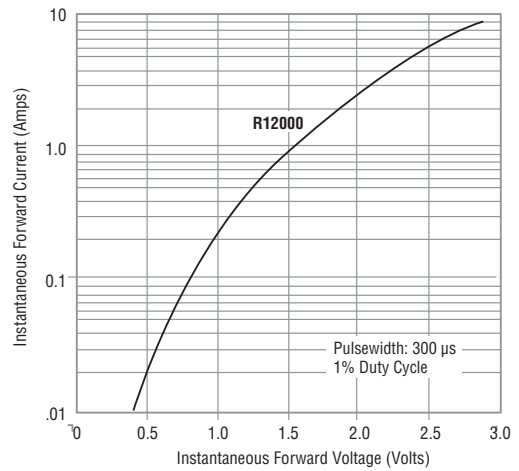
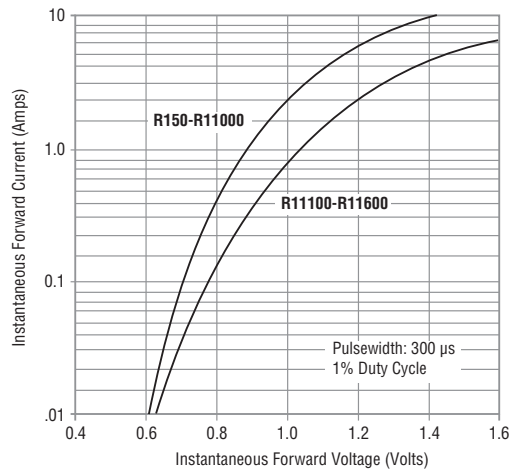

### Reverse Characteristics

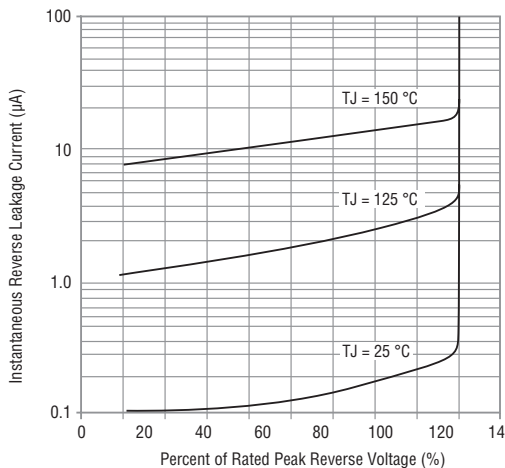

Specifications are subject to change without notice. The device characteristics and parameters in this data sheet can and do vary in different applications and actual device performance may vary over time. Users should verify actual device performance in their specific applications.

# CD214A-R150~R12000 Glass Passivated Rectifiers

**BOURNS®**

## Packaging Information

The surface mount product is packaged in a 12 mm x 4 mm tape and reel format per EIA-481 standard.

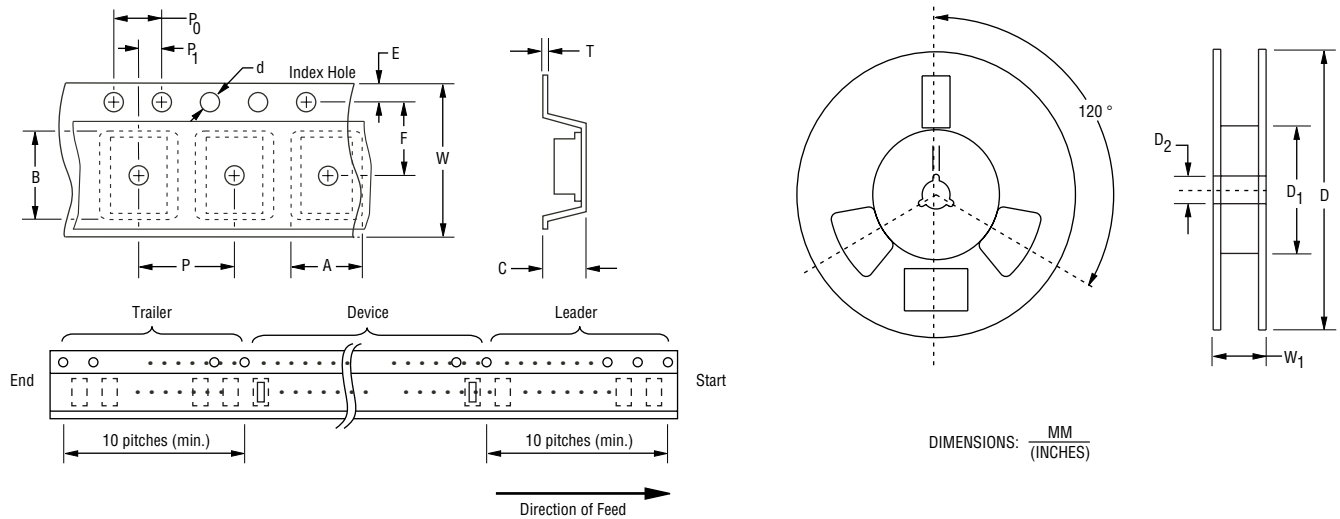

Item	Symbol	DO-214AC (SMA)
Carrier Width	A	$\frac{3.42 \pm 0.10}{(0.134 \pm 0.004)}$
Carrier Length	B	$\frac{5.07 \pm 0.10}{(0.199 \pm 0.004)}$
Carrier Depth	C	$\frac{3.10 \pm 0.10}{(0.122 \pm 0.004)}$
Sprocket Hole	d	$\frac{1.55 \pm 0.05}{(0.061 \pm 0.002)}$
Reel Outside Diameter	D	$\frac{330}{(12.992)}$
Reel Inner Diameter	D <sub>1</sub>	$\frac{50.0}{(1.969)}$ Min.
Feed Hole Diameter	D <sub>2</sub>	$\frac{13.0 \pm 0.50}{(0.512 \pm 0.020)}$
Sprocket Hole Position	E	$\frac{1.75 \pm 0.10}{(0.069 \pm 0.004)}$
Punch Hole Position	F	$\frac{5.50 \pm 0.50}{(0.217 \pm 0.020)}$
Punch Hole Pitch	P	$\frac{4.00 \pm 0.10}{(0.157 \pm 0.004)}$
Sprocket Hole Pitch	P <sub>0</sub>	$\frac{4.00 \pm 0.10}{(0.157 \pm 0.004)}$
Embossment Center	P <sub>1</sub>	$\frac{2.00 \pm 0.05}{(0.079 \pm 0.002)}$
Overall Tape Thickness	T	$\frac{0.30 \pm 0.10}{(0.012 \pm 0.004)}$
Tape Width	W	$\frac{12.00 \pm 0.20}{(0.420 \pm 0.008)}$
Reel Width	W <sub>1</sub>	$\frac{18.7}{(0.736)}$ Max.
Quantity per Reel	—	7,500

REV. 04/15  
 Specifications are subject to change without notice.  
 The device characteristics and parameters in this data sheet can and do vary in  
 different applications and actual device performance may vary over time.  
 Users should verify actual device performance in their specific applications.