

THIS DOCUMENT IS THE PROPERTY OF  
KEYSTONE ELECTRONICS CORP. AND  
SHALL NOT BE REPRODUCED, DISTRIBUTED  
OR USED AS A BASIS FOR MANUFACTURE  
WITHOUT PRIOR WRITTEN PERMISSION  
FROM KEYSTONE ELECTRONICS CORP.

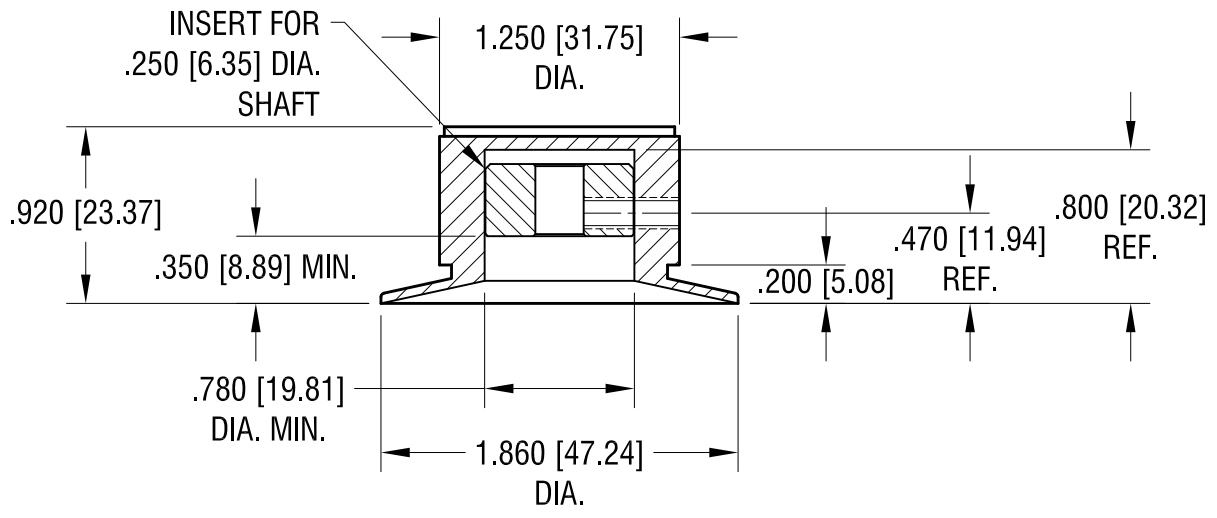
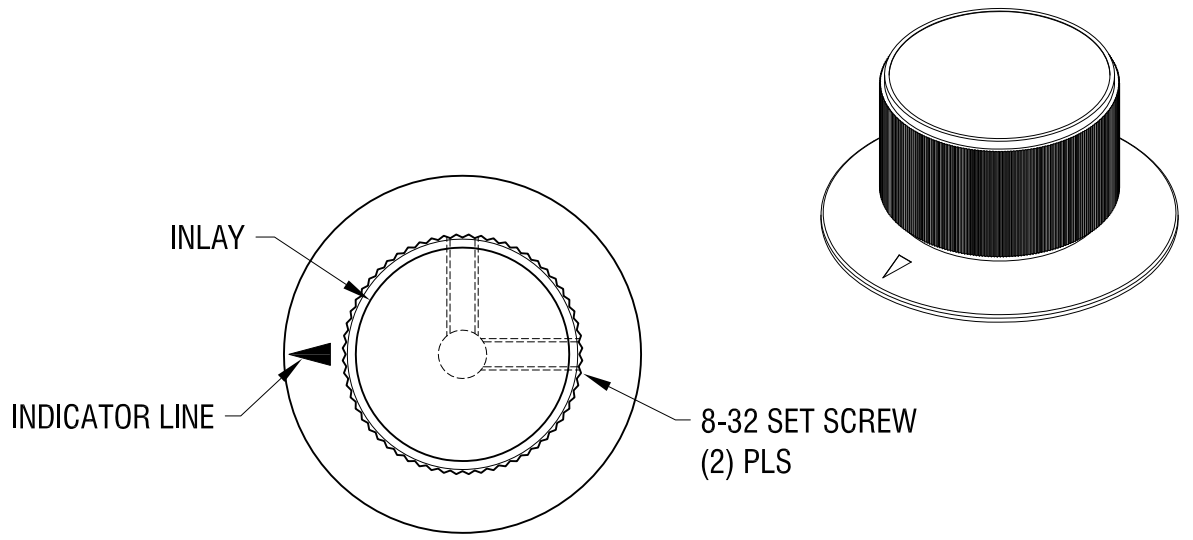

**NOTES:**

1. KNOB: MAT'L: ABS, BLACK
2. INSERT: MAT'L: BRASS, NICKEL PLATE
3. INLAY: MAT'L: SPUN ALUMINUM
4. SCREW: MAT'L- STEEL  
FINISH- BLACK OXIDE

<b>KEYSTONE ELECTRONICS CORP.</b>			
www.keyelco.com • ASTORIA, N.Y. 11105-2017 • Tel (718) 956-8900			
PART NAME		KNOB	
MATERIAL		AS NOTED	
FINISH		DRN BY	DATE
AS NOTED		BOONE	1.8.07
		APP'D	SCALE
		LN	1X
TOLERANCES	INCH [MM]	CODE	DWG NO.
DECIMAL	± .015 [± 0.38]	C	<b>8561</b>
ANGULAR	± 1°		
UNLESS OTHERWISE SPECIFIED			

DATE	DESCRIPTION	REV.	
------	-------------	------	--