

KEMET, SSHB21HS, Commercial Grade, 0.055 H

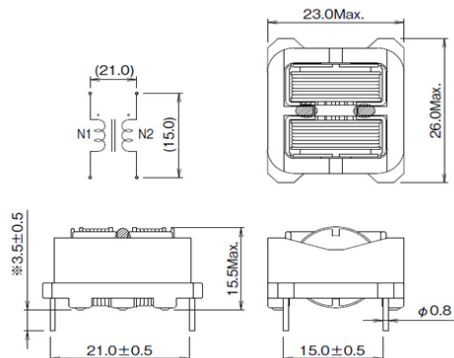

**Dimensions**

<b>L</b>	26mm MAX
<b>T</b>	23mm MAX
<b>H</b>	15.5mm MAX
<b>S</b>	15mm +/-0.5mm
<b>S1</b>	21mm NOM
<b>LL</b>	3.5mm +/-0.5mm
<b>F</b>	0.8mm NOM

**Packaging Specifications**

<b>Weight:</b>	14 g
<b>Packaging:</b>	Bulk
<b>Packaging Quantity:</b>	360

**General Information**

<b>Series:</b>	SSHB21HS
<b>Style:</b>	Through-Hole Choke
<b>Description:</b>	Common Mode Filter, SS Coils, SSHB21HS, Wide Range Impedance Type
<b>RoHS:</b>	Yes
<b>Miscellaneous:</b>	Temperature Rise Maximum: 55 K
<b>Notes:</b>	Marking: R07 Lot No.

**Specifications**

<b>Inductance:</b>	55 mH (10 kHz)
<b>Temperature Range:</b>	-25/+120C
<b>Rated Temperature:</b>	120C
<b>Current:</b>	0.7 Amps
<b>Voltage AC:</b>	250 VAC
<b>Withstanding Voltage:</b>	2400 VDC
<b>Insulation Resistance:</b>	100 MOhms